



# BAMBOO™



## User's manual for Windows® & Macintosh®

- Using a pen
- Customizing your pen
- Troubleshooting
- Using a tablet
- Customizing your tablet
- Digital inking





Bamboo™

User's Manual for Windows® & Macintosh®

English version 1.1, April 04, 2007

Copyright © Wacom Company, Limited, 2007

All rights reserved. No part of this manual may be reproduced except for your express personal use. Wacom reserves the right to revise this publication without obligation to provide notification of such changes. Wacom does its best to provide current and accurate information in this manual. However, Wacom reserves the right to change any specifications and product configurations at its discretion, without prior notice and without obligation to include such changes in this manual.



**Reuse, recycling, and recovery.** You are urged to recycle this product when replacing it with a newer product or when it has outlived its useful life by bringing it to an appropriate collection point for recyclable materials in your community or region. By doing this, you can help improve the environment of your community as well as minimize the potential negative effects created should any hazardous substance that may possibly be present within waste material reach the environment during the disposal process.

Within the European Union, users are required not to dispose of Waste Electrical and Electronic Equipment (WEEE) as unsorted municipal waste, according to the Directive 2002/96/EC of the European Parliament and of the Council of 27 January 2003, or the corresponding local laws of the Member States. Products for which this is applicable will be marked with the WEEE symbol shown at the beginning of this note unless this is not feasible because of the size or the function of the product. Wacom products are subject to the Directive 2002/96/EC and therefore you should always collect them separately and bring them to the appropriate collection point in your community or region.

Wacom pen tablet products comply with the European Union RoHS Directive 2002/95/EC (RoHS Directive).

Bamboo is a trademark and Wacom is a registered trademark of Wacom Company, Limited.

Adobe, Reader, and Photoshop are either registered trademarks or trademarks of Adobe Systems Incorporated in the United States and/or other countries. Microsoft, Windows, and Vista are either registered trademarks or trademarks of Microsoft Corporation in the United States and/or other countries. Apple, the Apple logo, and Macintosh are registered trademarks of Apple Computer, Inc., registered in the U.S. and other countries. Any additional company and product names mentioned in this documentation may be trademarked and/or registered as trademarks. Mention of third-party products is for information purposes only and constitutes neither an endorsement nor a recommendation. Wacom assumes no responsibility with regard to the performance or use of these products.

ExpressKey is a registered trademark of Ginsan Industries, Inc., and is used with permission.





## CONTENTS

About the manual	4	Technical support options	41
Navigating the manual	5	Obtaining driver downloads	42
<b>WORKING WITH BAMBOO</b>	6	<b>APPENDIX</b>	43
Tablet features	6	Pen and digital ink capabilities in Windows Vista	44
Bamboo pen	7	About the Windows Vista Tablet PC Input Panel	45
Setting up your work area	8	Caring for your tablet and tools	46
Using the cordless pen	9	Replacing the pen tip	46
Holding the pen	10	Uninstalling the tablet software	47
About the active area	11	Product specifications	48
Pointing	12	General specifications	48
Clicking	13	Bamboo tablet (model MTE-450)	48
Dragging	13	Bamboo pen (model EP-150E)	48
Using the pen buttons	14	Product information	49
Writing and inking with pressure sensitivity	15	Ordering parts and accessories	49
Erasing	15	Radio and television interference	50
Eye-hand coordination exercise	16	FCC notice	50
Working with the tablet	17	Industry Canada (Canada only)	50
Using the ExpressKeys	18	CE declaration	50
Using the Touch Ring	19	License and Warranties	
<b>CUSTOMIZING</b>	20	(Worldwide, except for Europe, Africa and Middle East)	51
Opening the control panel	20	Software License	51
Control panel overview	21	Limited Warranty	51
Control panel settings	21	Warranty Service in the U.S.A. and Canada	52
Customizing the pen	22	Warranty on Sales outside of the U.S.A. and Canada	53
Adjusting tip feel and double-click	23	License and Warranty	
Customizing the pen buttons	24	(Europe, Africa and Middle East)	54
Button functions	25	Software License Agreement	54
Tablet tracking	29	Entitlement to use the Software	54
Portion of screen area	31	Limited Warranty	54
Portion of tablet area	32	<b>GLOSSARY</b>	56
Setting mouse speed	32	<b>INDEX</b>	58
Customizing the tablet functions	33		
<b>TROUBLESHOOTING</b>	34		
Testing your tablet and pen	35		
Troubleshooting tables	37		
General problems	37		
Windows-specific problems	40		
Macintosh-specific problems	40		





## ABOUT THE MANUAL

This user's manual provides quick access to information about Bamboo. Just click on a navigation button or highlighted word to move through the document. The information is common to Windows and Macintosh computers and Windows screen captures are shown, unless otherwise noted.

- In the [contents](#) you can go directly to a topic by clicking on it.
- [Working with Bamboo](#) is the learning chapter, and introduces you to the many capabilities of your Bamboo pen tablet. It describes the pen tablet, the features and functions of the Bamboo pen, and includes exercises for new users. If you are not familiar with a pen tablet, this chapter gives you the basics.
- [Customizing](#) describes how you can change the control panel settings to optimize your Bamboo pen and tablet for the way you like to work.
- Want to test your tablet and pen? Need troubleshooting guidelines? [Troubleshooting](#) is where you will find the answers to most common questions.
- The [appendix](#) includes a variety of information: an overview of the new pen and [digital inking](#) capabilities found in Microsoft Windows Vista, tips on caring for your tablet and pen, a how-to on uninstalling the software, your license and warranty, and more.

**Note:** This manual does not contain information on installing your tablet. Please refer to your product Quick Start Guide and to the automated software installer (located on the Bamboo Pen Tablet Driver CD) for complete details on installing your pen tablet.

If you are new to electronic documentation, be sure to read [navigating the manual](#).

Here are some other points to keep in mind:

- SMALL CAPITAL LETTERS are used to identify the names of keyboard keys, dialog boxes, and control panel options.
- Remember that you can always use your viewer zoom-in tool to increase the size of the manual on your display screen.
- The following kinds of information are not included with this product: information about your specific computer hardware or operating system, or information about your application software. Your best source for this information is the set of manuals and disks that came with your hardware, operating system, or application.
- In addition to the built-in inking support found within Microsoft Windows Vista, many graphics applications also support pressure sensitivity and the pen eraser. You can find a listing of applications that support these features at Wacom's web site (see [product information](#)). For information on how best to use Bamboo features within a specific application, refer to the instructions in that application's manuals.





## NAVIGATING THE MANUAL

Use the navigation controls to move through the manual:



Go to front page.

CONTENTS

Go to table of contents.

INDEX

Go to index.



Go back to previous view.



Page back, or page forward.

HEADING TEXT

Go to beginning of section.

topic

Go to topic.



Topic continued.

Adobe Reader provides you with additional tools for using and printing the manual. Refer to the Adobe Reader help for more information.





## WORKING WITH BAMBOO

This section introduces you to the Bamboo pen tablet, which consists of two basic elements: a tablet that serves as your work area, and the [Bamboo pen](#) you use on the tablet.

The quickest way to learn about your pen tablet is to become familiar with its appearance and features. If you are new to using a pen tablet and tablet input tools, read the following sections to learn about the Bamboo pen and pen tablet.

[Tablet features](#)

[Bamboo pen](#)

[Setting up your work area](#)

[Using the cordless pen](#)

[Working with the tablet](#)

### TABLET FEATURES

Detachable cable.

Customizable Touch Ring.

Active area.  
See [About the active area](#).

Customizable ExpressKeys.  
The ExpressKeys are backlit and glow when the tablet power is on.

See [working with the tablet and customizing the tablet functions](#).



# BAMBOO PEN

Your Bamboo pen is cordless and battery-free.

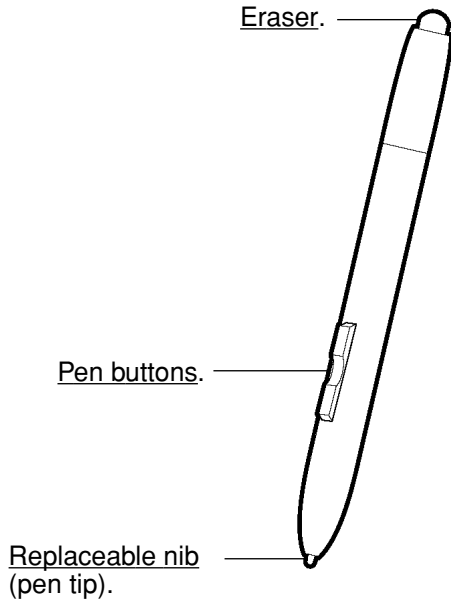

### Bamboo pen.

The pen is ideally suited to enhance your workflow by enabling the pen and digital ink features found within Microsoft Windows Vista and Office 2007. Take advantage of digital mark-up for collaborative editing and use digital ink to take notes in applications that support handwriting recognition. The pen is also an efficient freehand tool for pressure-sensitive image editing.

Note that the eraser is not pressure-sensitive.

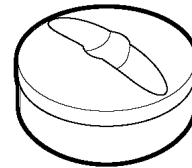

Pen stand.



## SETTING UP YOUR WORK AREA

To minimize fatigue, organize your work area so you can work comfortably. Position your tablet, pen, and keyboard so they are easily accessible without unnecessary reaching. Your monitor should be positioned so you can view it comfortably with a minimum of eyestrain. For best results, orient the tablet so the screen cursor follows the same direction as your hand movements on the tablet.



Here are some other points to keep in mind:

- Take short breaks between tasks to stretch and relax your muscles.
- Use a gentle grip when working with your pen.
- Alternate tasks and tools throughout the day.
- Maintain a good posture at all times. Minimize awkward postures and repetitive movements that cause discomfort.
- Change your position if you feel any discomfort due to your work position.

**Note:** Wacom makes no representation, promise or guarantee that Wacom products will cure or prevent, in whole or in part, mouse-induced repetitive stress symptoms, injuries or conditions. Individual results may vary. Always obtain competent medical advice to determine the most appropriate treatment for your specific situation.

See [working with the tablet](#) for more information.





## USING THE CORDLESS PEN

Your Bamboo pen is cordless, battery-free, and pressure-sensitive. There are four basic techniques for using the pen: pointing, clicking, double-clicking, and dragging. With a bit of practice, using the pen will become second nature to you. If you are unfamiliar with using the pen, try the exercises on the following pages.

**Important note for Windows Vista users:** To make the most of your pen in Microsoft Windows Vista, be sure to study the documentation that came with your system, including the Windows Vista training tools and Tablet PC tutorial. You can access the Tablet PC Pen Training from the Vista START menu by choosing ALL PROGRAMS, TABLET PC, and TABLET PC PEN TRAINING.

[Holding the pen](#)

[About the active area](#)

[Pointing](#)

[Clicking](#)

[Dragging](#)

[Using the pen buttons](#)

[Writing and inking with pressure sensitivity](#)

[Erasing](#)

[Eye-hand coordination exercise](#)





## HOLDING THE PEN

Hold the Bamboo pen like you would hold a normal pen or pencil. Make sure the pen buttons are in a convenient location where you can toggle them with your thumb, but not accidentally press them while writing or navigating with the pen. You can tilt the pen in any way that feels most comfortable.

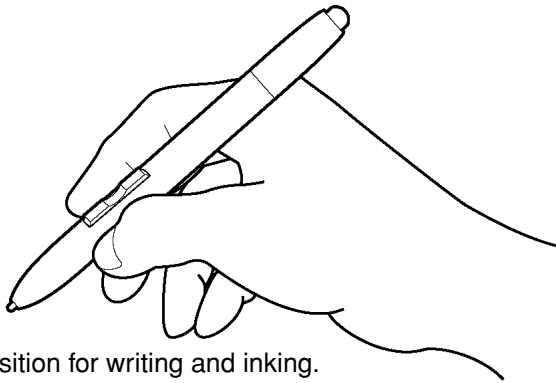

Position for writing and inking.

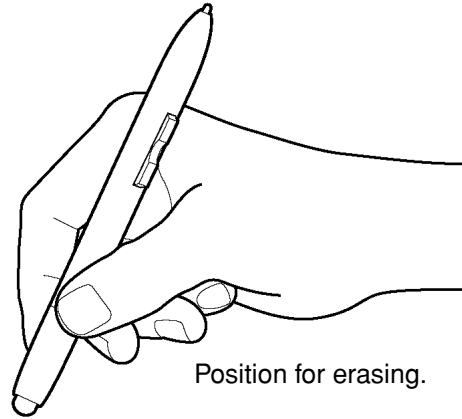

Position for erasing.

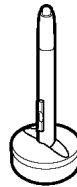
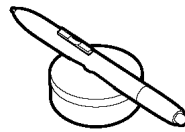

Use the pen stand to store the pen between tasks. This also makes the pen available for quick, easy access when you are working. The stand allows vertical or horizontal placement of the pen.

**Important:** When the pen is not in use, place it in the pen stand or lay it flat on your desk. To maintain the sensitivity of your pen tip, do not store the pen in a container where it will rest on its tip. Leaving the Bamboo pen on the tablet may interfere with screen cursor positioning when using other pointing devices. Also, leaving the pen on the tablet when not in use can prevent your computer from going to sleep.





## ABOUT THE ACTIVE AREA

The active area is the area of the tablet that senses pen movement. The screen area is the corresponding area on the screen.

The tablet active area is a mapped representation of your computer screen (a one-to-one relationship), and uses the entire screen. Wherever you place the pen on the tablet, the screen cursor will jump to the corresponding point on the screen. This is the default setting for the pen.

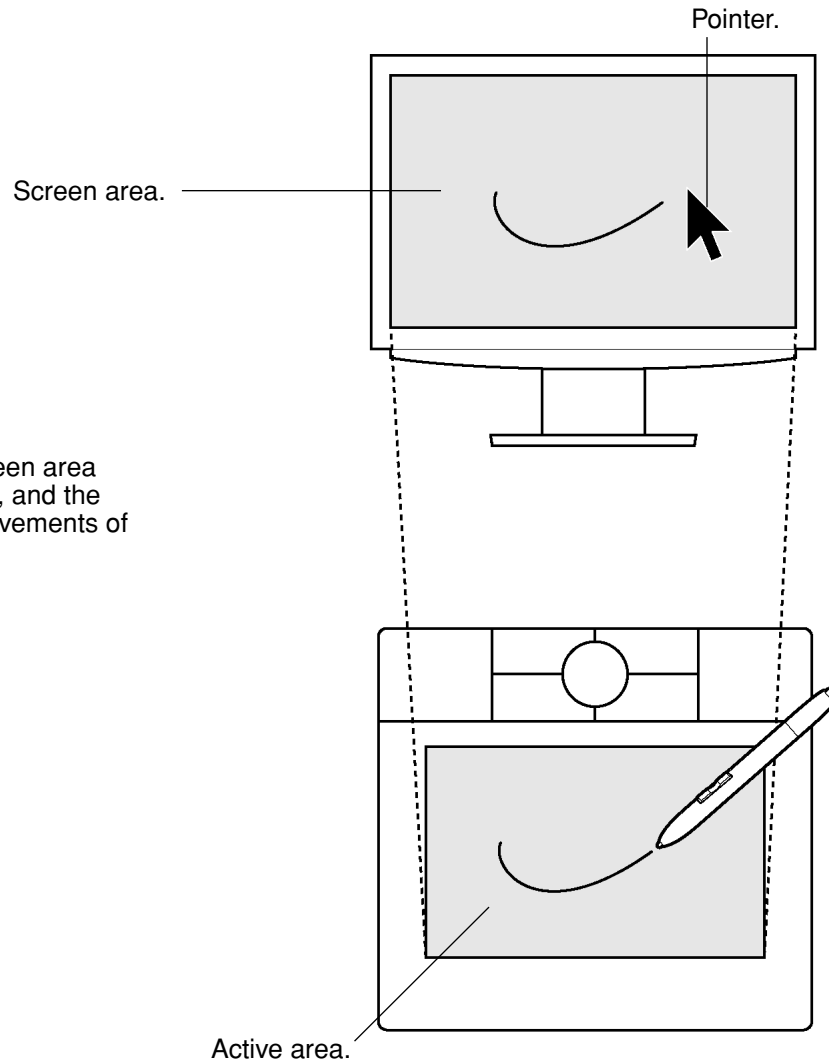

The pointer in the screen area indicates pen position, and the pointer follows the movements of the pen.





## POINTING

The Bamboo pen positions the pointer (or cursor) on your screen. You can position the screen cursor two different ways, like a pen (**PEN MODE**) or like a mouse (**MOUSE MODE**).

- In **PEN MODE**, the tablet active area is a mapped representation of your computer screen; wherever you place the pen on the tablet, the screen cursor will jump to the corresponding point on the screen. This is the default setting for the pen.
- In **MOUSE MODE**, you move the cursor with a “pick up and slide” motion similar to using a traditional mouse.

Try moving the screen cursor by lifting the pen and placing the pen tip in a new location on the tablet. The cursor instantly jumps to the new location.

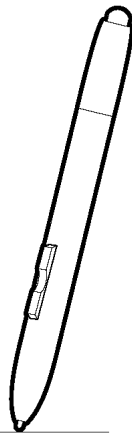
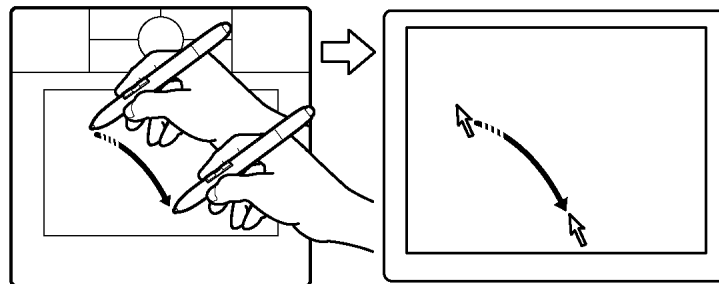
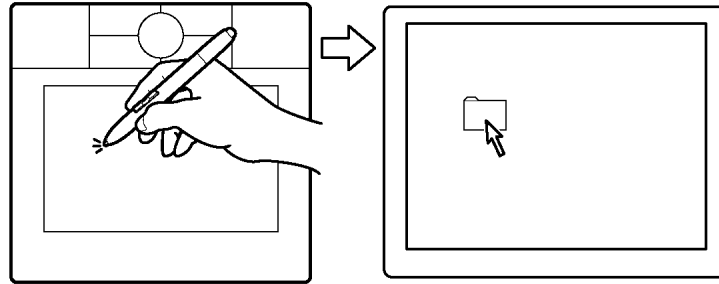

5 mm (0.20 inch)

When positioning the screen cursor and operating a pen button, the pen tip needs to be within 5 mm (0.20 inch) of the tablet surface. You do not need to touch the tablet with the pen tip in order to move the screen cursor or use a pen button.

### Hints:

- If you are used to working with a mouse and find that using a pen is somewhat difficult, try the eye-hand coordination exercise.
- Pointing is easier when you orient the tablet so the screen cursor follows the same direction as your hand movements on the tablet.





## CLICKING

You typically click to highlight or select something on the screen, and double-click to open it.

**Clicking.** To click, tap the pen tip once on the tablet, or press the pen tip on the tablet with enough force to register a click. (If **CLICK SOUND** is selected in the Pen Tablet control panel and your computer speakers are on, then you will hear a “click” sound when the pen tip is pressed hard enough to generate a mouse click. Adjust your speaker volume as necessary.) Try clicking on a folder icon by moving the screen cursor over the icon and pressing down on the pen tip. The folder should highlight when you press.

**Double-clicking.** To double-click, quickly tap the tablet twice in the same place with the pen tip. This is like clicking twice with a mouse button. Try double-clicking on a folder icon to open it.

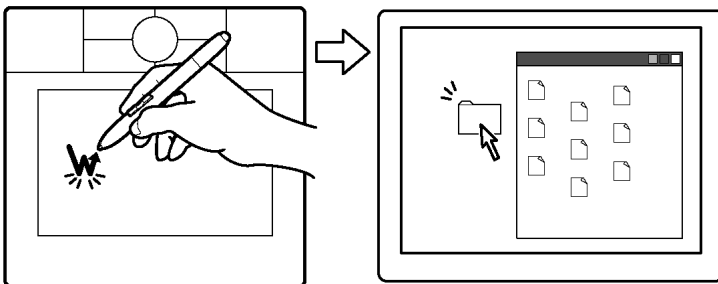
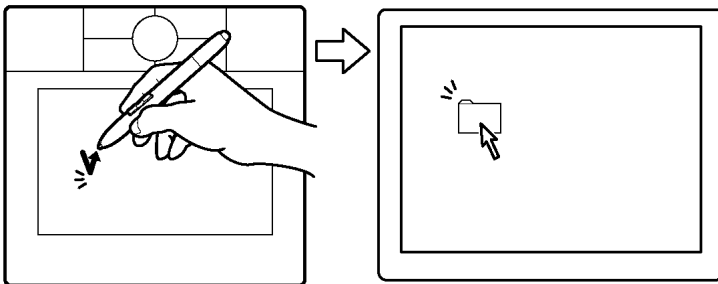

### Hints:

- **Windows:** You can make navigating with the pen easier by configuring Windows to select when the pen is over an icon and to launch the icon with a single click. To turn on this feature, first open a folder.

For *Windows Vista*, from the **ORGANIZE** pull-down menu choose **FOLDER AND SEARCH OPTIONS...** From the **GENERAL** tab select **SINGLE-CLICK TO OPEN AN ITEM (POINT TO SELECT)**.

For *other Windows versions*, from the **TOOLS** pull-down menu choose **FOLDER OPTIONS...** From the **GENERAL** tab select **SINGLE-CLICK TO OPEN AN ITEM (POINT TO SELECT)**.

- Set a pen button to **DOUBLE CLICK**. This is easier than tapping twice with the pen tip, and is the preferred method of double-clicking with a pen.

## DRAGGING

Dragging is used to select and move objects on the screen. To drag, first point to an object. Then press the pen tip to the tablet and slide it across the tablet surface. The selected object will move across the screen. To select text, move the screen cursor to the beginning of a text line, then drag the pen across the tablet until the text is highlighted.

First, try moving an icon on the screen. Then, within a document, select some text by pressing and dragging the pen tip across the text.

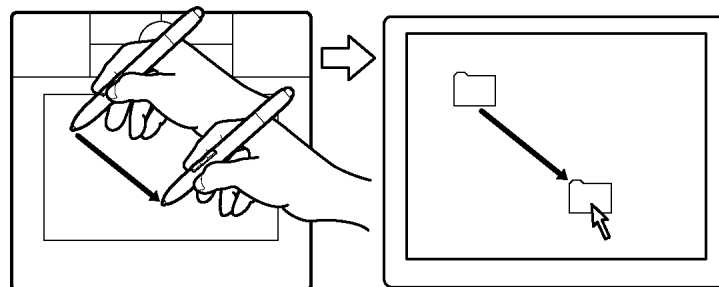

## USING THE PEN BUTTONS

The Bamboo pen is equipped with two buttons. Each button has a programmable function that is selected when you press the button. You can use a pen button whenever the pen tip is within 5 mm (0.20 inch) of the tablet active area. You do not have to touch the pen tip to the tablet in order to use a button.

The upper pen button is set to RIGHT CLICK, and the lower button is set to PAN/SCROLL by default.

- Use RIGHT CLICK to bring up application-specific or icon-specific menus.
- PAN/SCROLL lets you position a document or image in any direction within the active window simply by pressing the pen button and moving the pen tip across the tablet's active area. As you move the pen tip, the document or image is repositioned to follow the direction of pen movement on the tablet. Release the pen button or lift the pen tip from the tablet surface when you are done.

In some application windows the document will precisely follow the screen cursor as you move the pen tip, while in others it will simply move in the same general direction as the screen cursor.

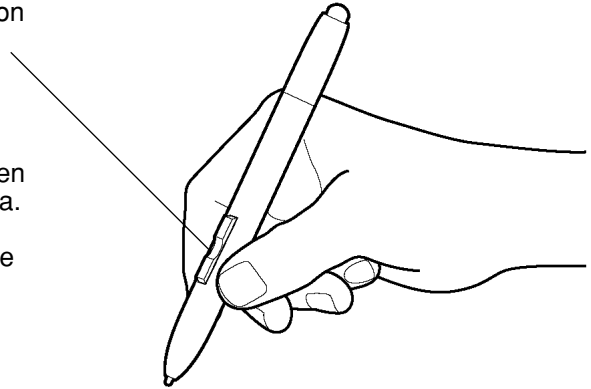

**Hint:** Set a pen button to DOUBLE CLICK. This is easier than tapping twice with the pen tip.

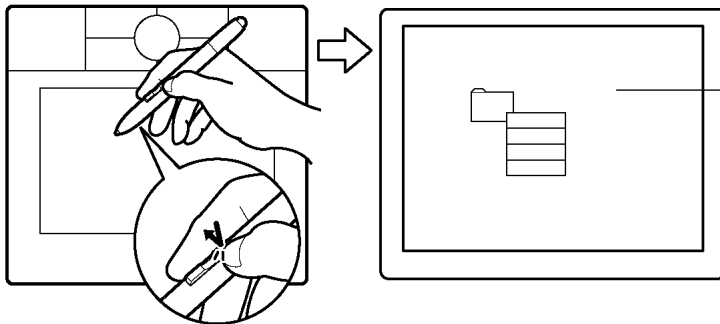

Example of right click on computer display.

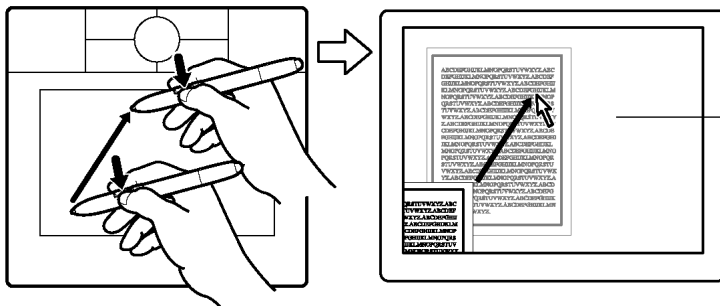

Example of pan/scroll movement on computer display.

To assign new button functions, see customizing the pen buttons.



## WRITING AND INKING WITH PRESSURE SENSITIVITY

The Bamboo pen responds to the nuance and inflection of your hand movements, enabling you to create natural-looking handwriting and ink strokes. The digital ink tools in Microsoft Windows Vista and Office 2007, as well as the drawing tools in many graphics applications, respond to the pressure you place on the pen. For example, sliders are used in some applications to vary line characteristics (width, color, and opacity). These characteristics can be controlled much better by the pen's pressure sensitivity – you can vary line width, blend colors, and change opacity with the pressure you exert upon the pen.

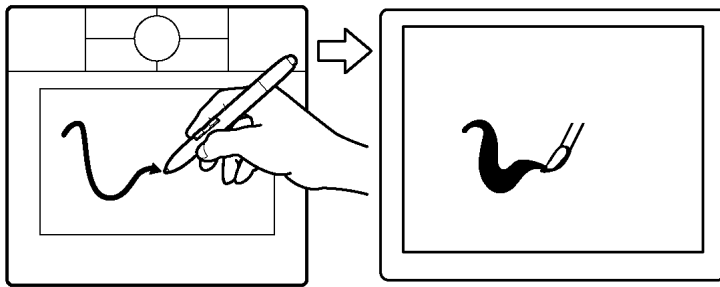

To write, ink, or sketch with pressure sensitivity, move the pen along the surface of the tablet while applying various amounts of pressure downward on the tip of the pen. Press hard for thick lines or dense color. Press gently for thin lines or softer color. Note that some applications require that you first select a pressure-sensitive tool from the application's tool palette.

To adjust the tip feel, see [adjusting tip feel and double-click](#).

Visit our web site for a list of applications that support pressure. See [product information](#).

## ERASING

The Bamboo pen eraser works like the eraser on a pencil. Use the pen eraser in Microsoft Windows Vista and Office 2007 to erase notes or sketches made with digital ink, and to select and delete text or spreadsheet cells within an application. In graphics applications that support the pen eraser, you can erase intuitively and naturally. When you use the pen eraser, the application will automatically switch to the eraser tool. Please note that the eraser is not pressure-sensitive.

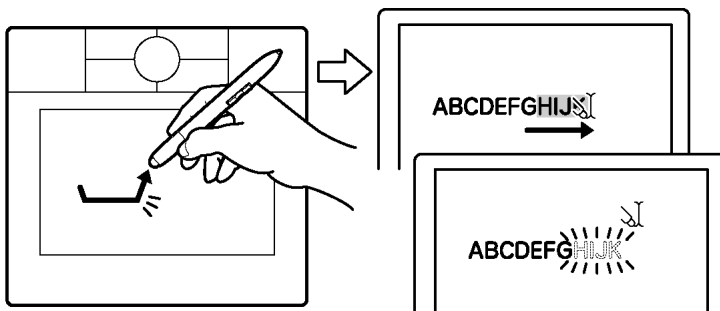

Visit our web site for a list of graphics applications that support the eraser (see [product information](#)). If the eraser is not supported in an application, you can still use the eraser for navigating, inking, annotation, or sketching.

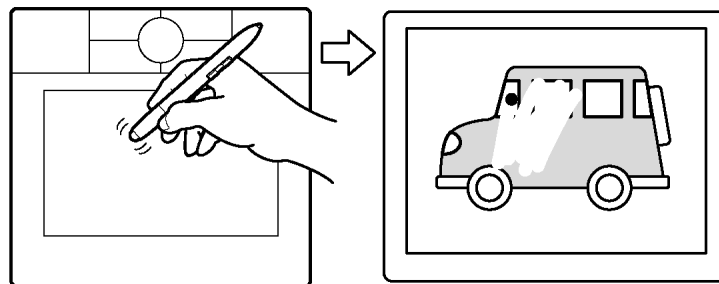



## EYE-HAND COORDINATION EXERCISE

If you use a mouse, you may remember how long it took to get used to positioning the screen cursor. Your Bamboo pen, likewise, will take a bit of practice to master the technique of positioning the screen cursor in PEN MODE. This may seem difficult at first, but it is more natural and faster than in MOUSE MODE.

This exercise is designed to retrain your eye-hand coordination for using the pen:

1. Open any graphics application. Use the line tool to sketch a rectangular grid with line spacings of about 20-25 mm (3/4 to 1 inch). You can use your traditional mouse to do this.
2. Choose a free-hand tool in your application and use the pen to add a dot at each grid intersection.
3. Place an X at each grid intersection.
4. Now sketch a circle around each intersection. Your screen should look like this:

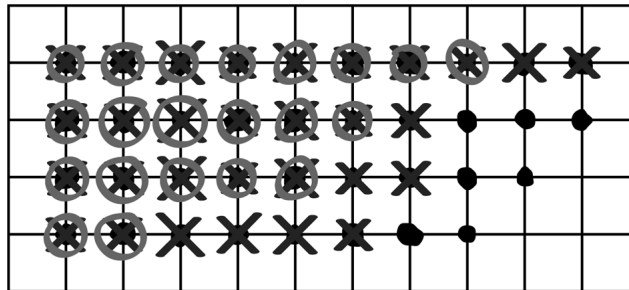

5. Clear your screen and make a simple illustration of your own. The more you use your pen, the easier writing, inking, and navigation will become.





## WORKING WITH THE TABLET

Your Bamboo pen tablet is designed to enhance the way you work. The middle area of the tablet is the working, or active, area for the pen. Rest your hand on the tablet and then work with the pen on the active area of the tablet just as if you were using a ball point pen on a piece of paper. Wherever you place your pen on the tablet active area, the screen cursor will jump to the corresponding point on the screen. See [using the cordless pen](#) for more information about using your input device on the tablet.

Your tablet also features a customizable Touch Ring and ExpressKeys located above the tablet active area for frequently used functions. For example, you can zoom in or out of a document you are editing without removing your hands from the tablet.

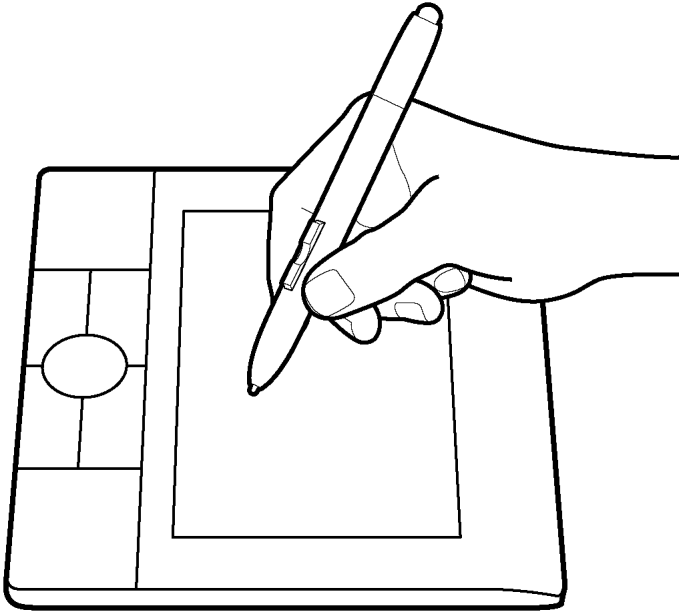

**Touch Ring.** Slide your finger over the Touch Ring to zoom or scroll. By default the Touch Ring is set for zoom functionality.

- Move your finger clockwise to zoom in on a document or image.
- Move your finger counterclockwise to zoom out.

See also [customizing the tablet functions](#).

**ExpressKeys.** Press the customizable ExpressKeys to perform frequently used functions or keystrokes.

By default, the upper keys are set to move FORWARD (right key) or BACK (left key) within your Internet browser.

On Windows Vista systems the lower left button defaults to JOURNAL when the [Journal](#) application is available. Otherwise, the button is set to SHOW DESKTOP.

For the lower right button, the default condition is SWITCH APPLICATION on Windows systems and EXPOSÉ on Macintosh systems.

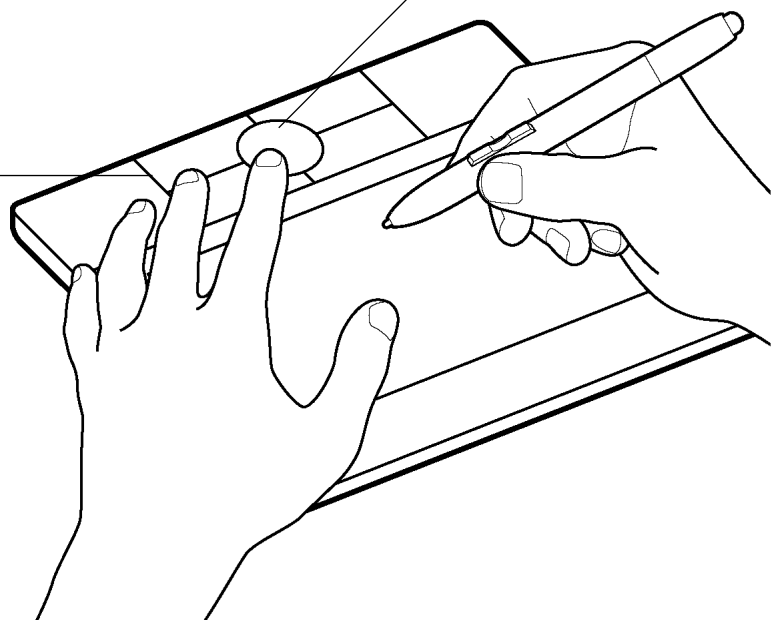



## USING THE EXPRESSKEYS

Press the ExpressKeys to perform frequently used functions. The ExpressKey default settings will vary depending on which operating system you are using.

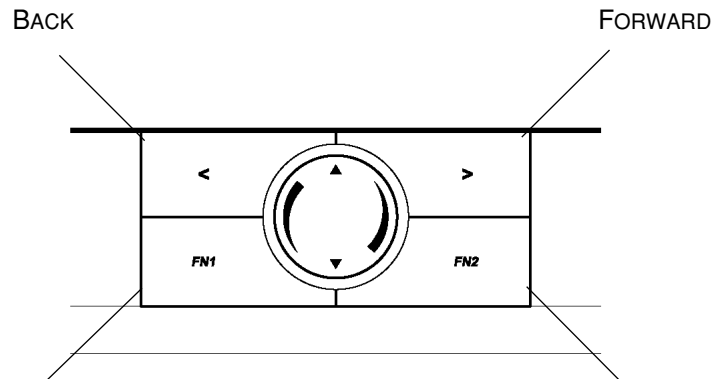
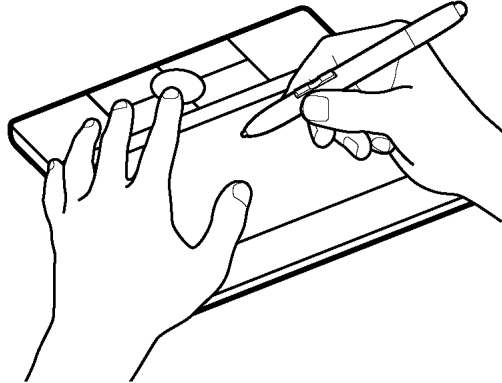

- Windows Vista (Aero): RUN MICROSOFT JOURNAL
- All others: SHOW DESKTOP
- Windows Vista (Aero): APPLICATION SWITCH (FLIP 3D)
- Windows Vista, XP, or 2000: APPLICATION SWITCH
- Macintosh: EXPOSÉ

The ExpressKeys are fully customizable, enabling you to make the best possible use of them. You may want to consider some of these alternate ways of using the ExpressKeys:

- Set a key to a commonly used keyboard shortcut.
- Set a key to launch a commonly used file or application, such as your email program.
- Choose from any of the other available [functions](#).

Note also that the tablet ExpressKeys are chordable, which means you can operate them simultaneously. For example, if you program one key to simulate the CTRL key and another to simulate an ALT keystroke, when you press both keys a CTRL+ALT is simulated.

See [customizing the tablet functions](#) for more details on the available settings.





## USING THE TOUCH RING

The Touch Ring lets you scroll and zoom in your current document.

- **Zooming:** Slide your finger clockwise to zoom in, and counterclockwise to zoom out.

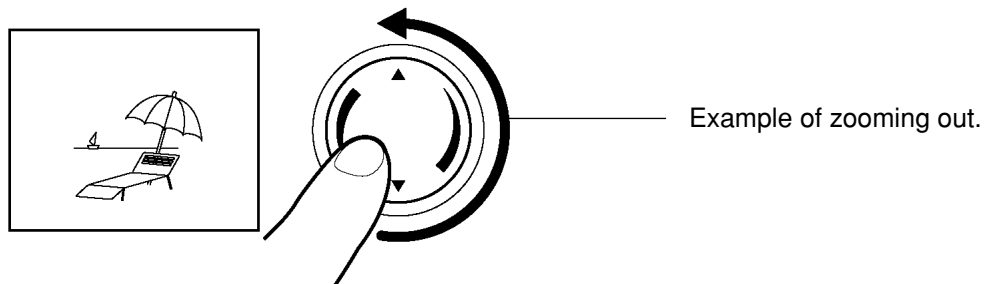
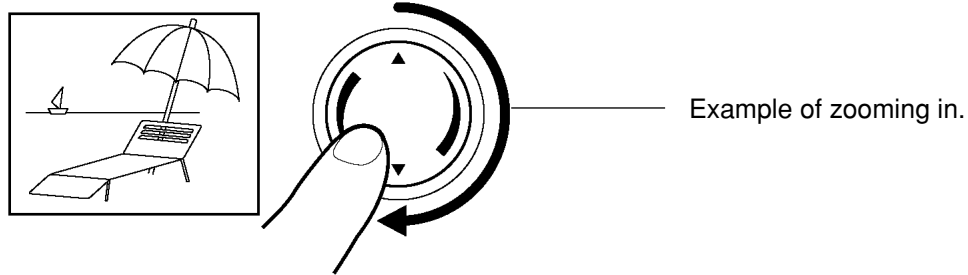

- **Continuous scrolling:** Press and hold your finger at the upper end of the Touch Ring to continuously scroll up. Press and hold your finger at the lower end of the Touch Ring to continuously scroll down.
- **Single step scrolling:** Tap your finger on the upper end of the Touch Ring to scroll up one step at a time. Tap your finger on the lower end of the Touch Ring to scroll down one step at a time.

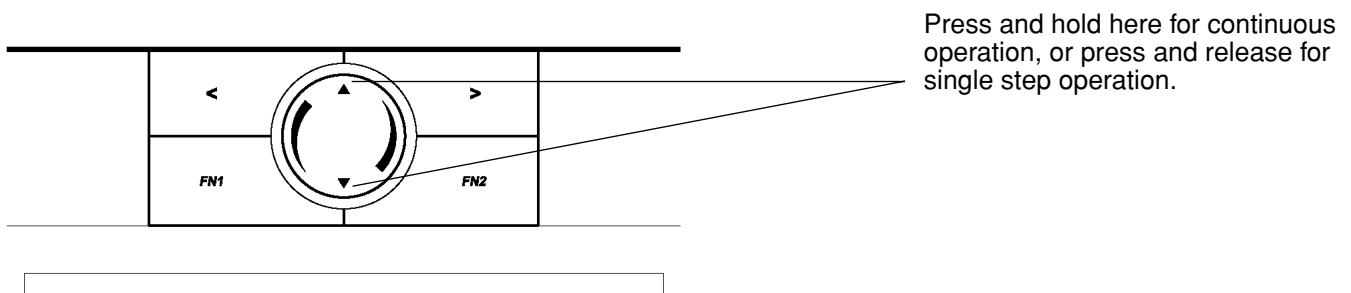

You can also set the Touch Ring to scroll when you slide your finger around the ring. See [customizing the tablet functions](#).





## CUSTOMIZING

After you master the basics of using your Bamboo pen tablet, you may want to customize the way the pen or tablet works. This chapter describes how to use the Pen Tablet control panel to adjust your tablet and pen settings.

[Opening the control panel](#)

[Control panel overview](#)

[Control panel settings](#)

### OPENING THE CONTROL PANEL

To open the control panel, use the Bamboo pen on the tablet:

- **Windows.** Click on the Windows START button and choose ALL PROGRAMS. (For Windows 2000, choose the PROGRAMS group.) Then select TABLET and choose the PEN TABLET option.
- **Macintosh.** Open SYSTEM PREFERENCES from either the Dock, the Apple menu, or from the APPLICATIONS folder. Then click on the PEN TABLET icon.

After you have opened the Pen Tablet control panel, you can begin customizing Bamboo.

**Note:** When more than one Wacom tablet is installed on a single computer, any changes made in the Pen Tablet control panel will be applied only to the tablet that was last used before opening the control panel.





## CONTROL PANEL OVERVIEW

Use the Pen Tablet control panel to customize your Bamboo pen and tablet.

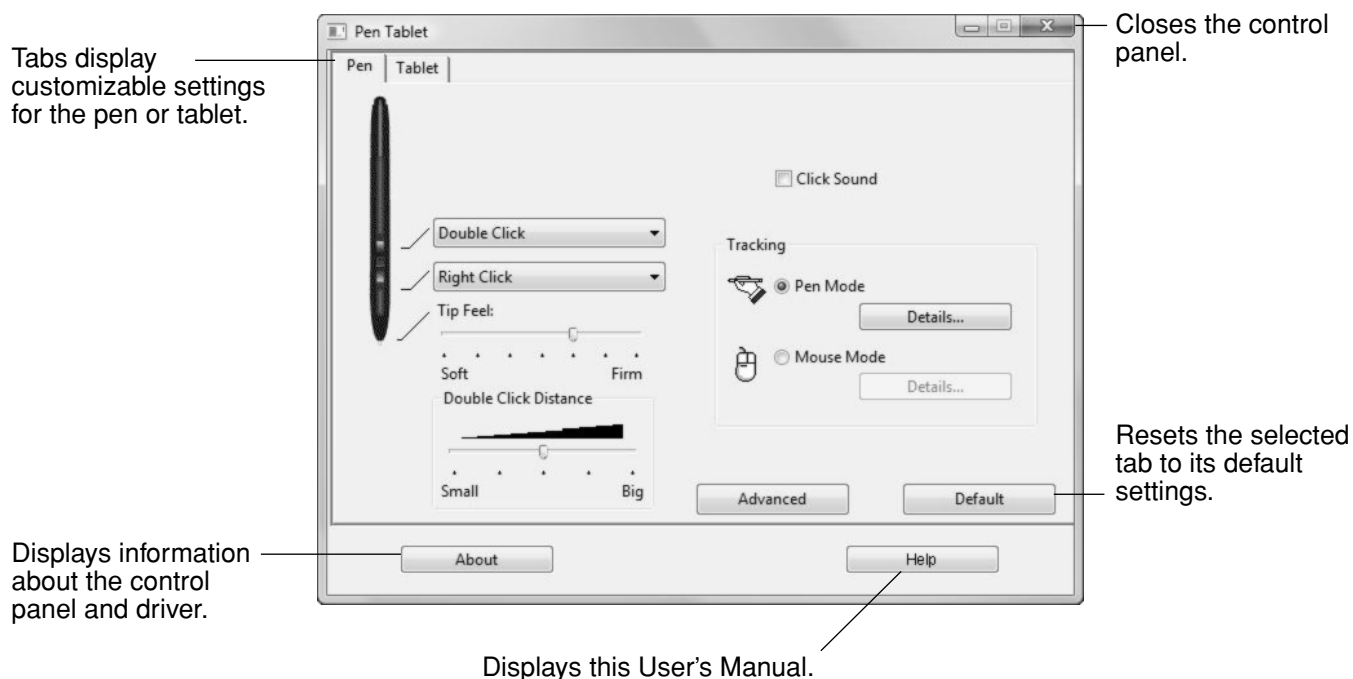

As you explore the control panel, experiment with different settings to find what works best for you. Any changes you make will take effect immediately, but you can always click **DEFAULT** to return a tab to the factory settings. See control panel settings for more information on the features and functions of each tab.

Tool Tips are available for most control panel items. Simply position the screen cursor over an item and let it rest there; in a few moments the Tool Tip will pop up.

Additionally, your keyboard tab and arrow keys can be used to navigate the control panel.

## CONTROL PANEL SETTINGS

Use these sections as a reference when working with the Pen Tablet control panel; they provide detailed information about each tab. Many of the sections also contain useful customizing tips.

[Customizing the pen](#)

[Tablet tracking](#)

[Customizing the tablet functions](#)





## CUSTOMIZING THE PEN

Customizing your Bamboo pen is easy. First open the Pen Tablet control panel and select the PEN tab to choose from the available options.

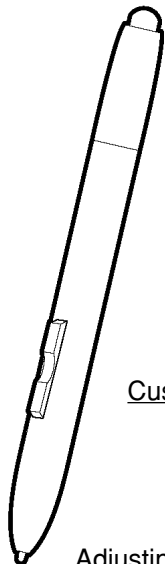

Customizing the pen buttons

Adjusting tip feel and double-click

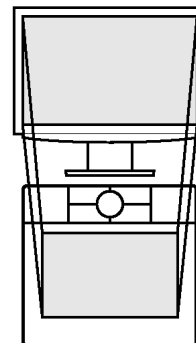

Tablet tracking





## ADJUSTING TIP FEEL AND DOUBLE-CLICK

To adjust the tip sensitivity of your Bamboo pen, select the PEN tab. To create broad inking strokes or to click with a light touch, use a soft tip setting. For maximum control while inking thin lines, use a firm tip setting.

Customizes the amount of pressure needed to click, write, or ink. Drag the slider to a softer or firmer setting.

Adjusts the size of the double-click area and the double-click speed. A larger setting makes double-clicking easier.

When checked, an audible “click” sound will be heard whenever a pen click occurs and your computer speakers are turned on.

### Hints:

- Use a soft TIP FEEL for a wider range of pressure values with most pressure-sensitive applications.
- In some applications, a soft pressure setting can make the pen overreact – any small press on the pen is magnified on the screen. If you experience this, try a firmer TIP FEEL setting.
- Double-clicking: To make double-clicking easier, expand the tap area that accepts a double-click (the double-click distance).

**Note:** A large double-click distance may cause a delay at the beginning of a drag action or inking stroke. If you notice such effects, try setting a smaller double-click distance and using a pen button to double-click (see [using the pen buttons](#)).



## CUSTOMIZING THE PEN BUTTONS

Select the PEN tab to change the functions assigned to the buttons on your Bamboo pen. Each pen button can be set to simulate a variety of mouse functions; the pull-down menus enable you to choose the function that will be performed.

Select the function to perform when pressing the upper or lower pen button.

When you bring the pen tip within 5 mm (0.20 inch) of the tablet surface without touching the tablet and press the upper or lower pen button, the selected function occurs.

**Hint:** To make double-clicking easier, set a pen button to double-click automatically by selecting DOUBLE CLICK.

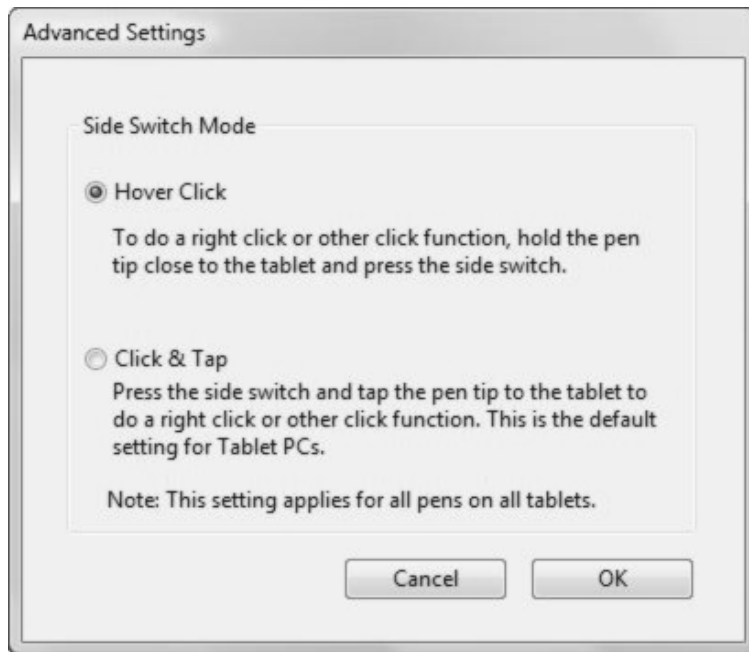
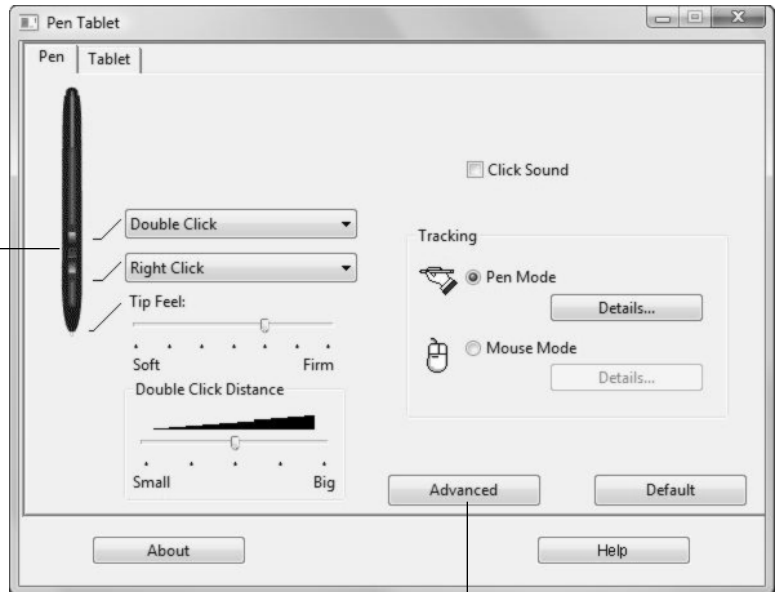

**Note:** You can change the SIDE SWITCH MODE to best fit the way you like to use the pen when making right-clicks or other click functions. To access the SIDE SWITCH MODE settings, click on the ADVANCED button. In the dialog box that appears:

- Select HOVER CLICK to perform click functions without touching the pen tip to the tablet surface.
- When CLICK & TAP is selected, you must first press the pen button and then touch the pen tip to the tablet surface in order to perform a click function. CLICK & TAP enables the precise placement of your click functions, and is the default setting for Tablet PCs.

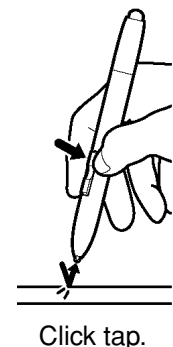



## BUTTON FUNCTIONS

The following options are available for pen and tablet button settings. Please note that not all options are available for all controls.



**CLICK.** Default setting for the pen tip. This option simulates a primary mouse button click.

**DOUBLE CLICK.** Simulates a double-click. For easier double-clicking, use this function instead of tapping twice with the tip of your pen.

**MIDDLE CLICK.** Simulates a middle mouse button click.

**RIGHT CLICK.** Simulates a right mouse button click, which displays a context menu.

**CLICK LOCK.** Simulates holding down the primary mouse button. Press the tool button once to initiate click lock. Press the button again to release click lock. Click lock is useful for dragging objects or selecting blocks of text.

**BACK.** Simulates a 4th mouse button click, which on Windows systems typically issues the BACK command in browser applications.

**FORWARD.** Simulates a 5th mouse button click, which typically issues the FORWARD command in browser applications.

**PAN/SCROLL.** Enables you to move a document or image in any direction within the active window using your Bamboo pen.





**INK TOGGLE.** (Macintosh.) Toggles the INK ANYWHERE function of Inkwell on and off. Inkwell automatically recognizes and converts your handwriting into text and inserts it into a document. Note that Ink must be turned on for this function to work. See your Macintosh help for information on working with Inkwell.

**TABLET PC INPUT PANEL.** (Tablet PCs and Windows Vista systems that support the Tablet PC Input Panel.) Opens the Tablet PC Input Panel when you press a tool button set to this function.

**JOURNAL.** (Windows Vista and Tablet PC systems that include Microsoft Journal.) Opens Microsoft Journal.

**MODE TOGGLE....** Toggles between PEN MODE and MOUSE MODE. See [setting mouse speed](#) for details.

[MODIFIER....](#) Enables you to simulate modifier keys.

[KEYSTROKE....](#) Enables you to simulate keystrokes.

[OPEN/RUN....](#) Opens an application, file, or script.

**SHOW DESKTOP.** Minimizes all open windows to display a clean desktop.

**SWITCH APPLICATIONS.** Brings up the application switching dialog with focus on the next open application. On Windows Vista systems running Aero, Flip 3D will be activated with focus on the next open application.

**EXPOSÉ.** (Macintosh.) Tiles all open windows.

**DISABLED.** Disables the button function.

**DEFAULT.** Returns a button to its default setting.



- **PAN/SCROLL.** (Pen only.) Lets you position a document or image in any direction within the active pane simply by pressing a pen button set for PAN/SCROLL and then moving the pen tip across the tablet's active area.

When you select PAN/SCROLL, the PEN SCROLLING SPEED dialog box prompts you to set a scrolling speed that will be used in applications that do not support grabber hand (pixel-level) panning within a document or image.

- Select SLOW to use more pen movement with a slower scroll rate. This is a good choice for close-up and detail work where you need precise control of the image.
- Select FAST to use less pen movement with a faster scroll rate.

This setting will not apply to applications that support grabber hand panning.

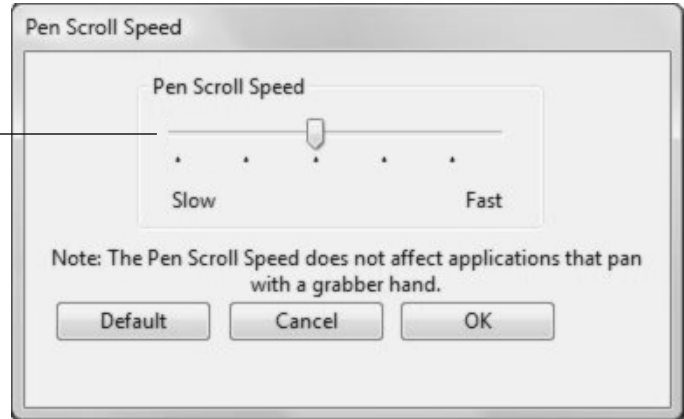

- **KEYSTROKE....** Enables you to simulate keystrokes. Selecting this option displays the DEFINE KEYSTROKE dialog box where you can enter a keystroke or keystroke sequence to play back.

You can manually enter a keystroke or keystroke combination in the KEYS entry box. Keystroke combinations can include letters, numbers, function keys (such as F3) and modifier keys (such as SHIFT, ALT, or CTRL for Windows, or SHIFT, OPTION, COMMAND, and CONTROL for Macintosh).

You can also select special keystrokes or keystroke combinations from the ADD SPECIAL drop-down menu. When you make a selection it is added to the KEYS entry box.

After defining a keystroke sequence, click OK.

**Important:** Because the ENTER (Windows) and RETURN (Macintosh) keys can be selected as a defined keystroke, they cannot be used to select OK. You must use your Bamboo pen to click on the OK button.

If prompted, enter a name for the keystroke definition. The name will be displayed with the respective control.

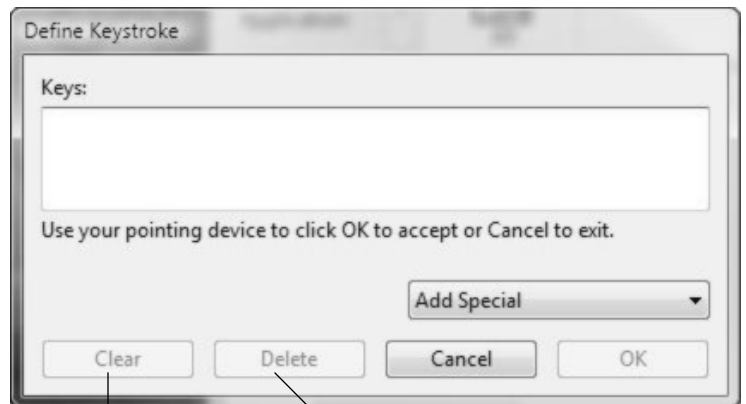

Deletes only the last entry in the keystroke entry box.

Clears the keystroke entry box.





- **OPEN/RUN....** Opens a dialog box where you can select a specific application, file, or script to launch.

Click BROWSE... to locate an application, file, or script to launch. The selection you make appears in the APPLICATION TO RUN box.

Click OK to accept the selection. The dialog box will close and the OPEN/RUN... option will be assigned as your tool button option.

The next time you press the tool button, the defined application, file, or script will launch.

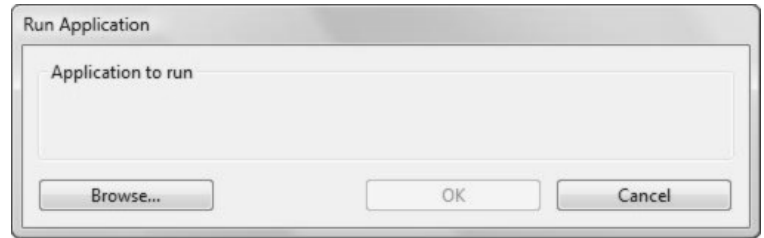

- **MODIFIER....** Enables you to assign modifier key(s) (such as SHIFT, ALT, or CTRL for Windows, or SHIFT, OPTION, COMMAND, and CONTROL for Macintosh). Many applications use modifier keys to constrain the size or placement of objects. Selecting this option displays the DEFINE MODIFIER dialog box where you can assign one or more modifier key functions. After choosing the modifier function(s), click OK.

In addition to choosing one or more modifier key options, you can select the CLICK box if you want a mouse click to occur whenever you press the tool button.

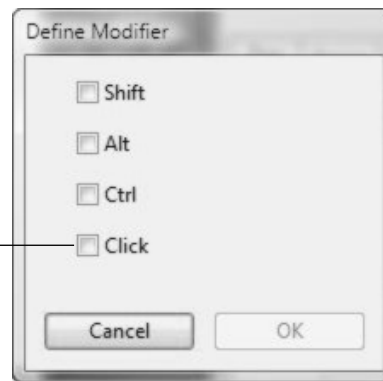



## TABLET TRACKING

The tablet TRACKING options enable you to define the relationship between pen movement on the tablet surface and cursor movement on the monitor screen. By default the entire active area of the tablet maps to the entire monitor. If more than one monitor is in use the tablet will map to all monitors. See [mapping to multiple monitors](#).

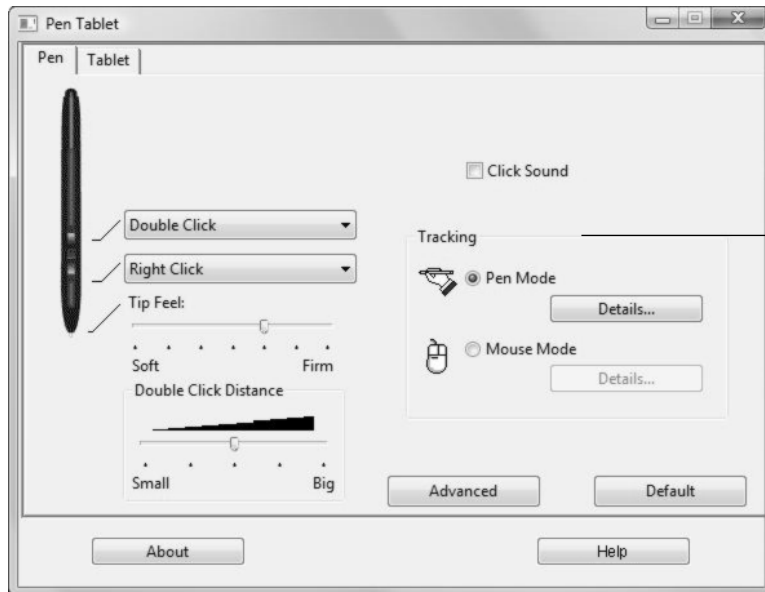

The TRACKING mode you select controls how the screen cursor moves:

- Select PEN MODE to set the cursor so that its movement corresponds with the position of your Bamboo pen on the tablet – wherever you place your pen on the tablet, the cursor will jump to a corresponding point on the screen. This is known as absolute positioning, and is the default setting for the Bamboo pen. Click DETAILS... to customize the [tablet mapping](#).
- Select MOUSE MODE to move the screen cursor with a “pick up and slide” motion similar to using a traditional mouse. Click DETAILS... for [setting mouse speed](#).

**Note:** If you frequently switch between PEN MODE and MOUSE MODE, you can assign the MODE TOGGLE... function to one of your pen buttons or ExpressKeys.



When you click on the PEN MODE DETAILS... button, the PEN MODE DETAILS dialog box is displayed.

Use the SCREEN AREA options to select a screen area for tablet to screen mapping.

- **ALL SCREENS.** The entire monitor(s) area is mapped; this is the default setting. See mapping to multiple monitors for more information.
- **MONITOR.** The entire area of a single monitor that you choose is mapped.
- **PORTION.** A portion of the desktop area is mapped. Click SET... to open a dialog box where you can set the portion of screen area.

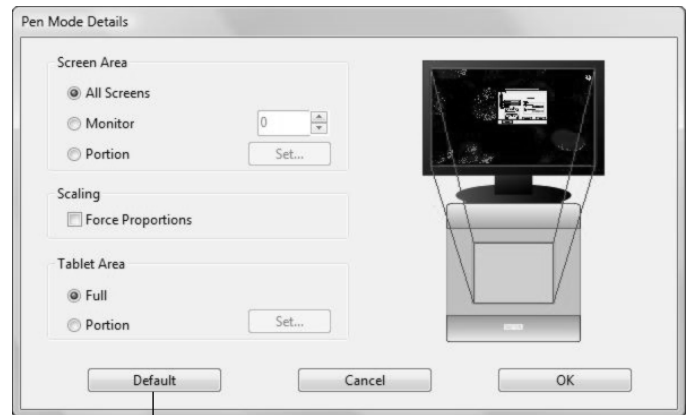

Returns settings to their factory defaults.

**FORCE PROPORTIONS.** Check or uncheck the box to determine the tablet to screen mapping relationship.

- When unchecked, the correct scale or proportions are not maintained. The selected tablet area is mapped to the selected display area. An inked word on the tablet may appear distorted on the display screen. This is the default setting.
- When checked, the correct vertical and horizontal proportions are maintained between the tablet and display. Inking a word on the tablet results in a correctly proportioned word on the display screen. Depending on your settings, some portions of the tablet active area may no longer be usable when this option is selected.



Use the TABLET AREA options to select a tablet area for tablet to screen mapping.

- **FULL.** The entire active area of the tablet is mapped. This is the default setting.
- **PORTION.** A portion of the tablet area is mapped. Click SET... to open a dialog box where you can set the portion of tablet area.

**Note:** Although Bamboo is optimized for use with 16 : 10 aspect ratio displays, the default settings automatically adjust for use with other aspect ratio displays.

### Mapping to multiple monitors

If your computer has more than one monitor, Bamboo will map to your monitors based upon how they are configured in the DISPLAY PROPERTIES control panel. If ALL SCREENS is selected and you are in extended monitor mode, the tablet will map to all monitors as if they were one large display. If the monitors are in mirror mode, the tablet will map to the entire space on each monitor and the screen cursor will be displayed on each monitor simultaneously.

Please refer to your hardware and operating system documentation for details on configuring your computer and operating system for use with multiple monitors.



## PORTION OF SCREEN AREA

The tracking options in the PEN MODE DETAILS dialog box allow you to define which portion of the display screen your tablet will map to:

- **ALL SCREENS.** When selected, the entire monitor(s) area is mapped. This is the default setting. See [mapping to multiple monitors](#) for more information.
- **MONITOR.** When selected, the entire area of a single monitor that you choose is mapped.
- **PORTION.** When selected, this option allows you to select a portion of the display for tablet to screen mapping. Click SET... to open the PORTION OF SCREEN dialog box.

Choose a method for defining a portion of the display:

- Drag corners of the foreground graphic to select the screen area. The background graphic represents the entire screen area.
- Move the screen cursor to select the screen area. Select the CLICK TO DEFINE SCREEN AREA button. As you define PORTION OF SCREEN, follow any MESSAGE prompts to set the portion of your display screen that will be used for mapping.

After defining a portion of the screen, you may need to use a different input device to access other portions of the screen area.



## PORTION OF TABLET AREA

The tracking options in the PEN MODE DETAILS dialog box allow you to define the tablet area that will be mapped to the screen area:

- **FULL.** When selected, the entire active area of the tablet is used for tablet to display mapping. This is the default setting.
- **PORTION.** When selected, this option allows you to select a portion of the tablet active area for tablet to screen mapping. Click SET... to open the PORTION OF TABLET dialog box.

Choose a method for defining a portion of the tablet:

- Drag corners of the foreground graphic to select the tablet area that will be mapped to your selected screen area. The background graphic represents the tablet.
- Use your pen on the tablet to select the tablet area. Select the CLICK TO DEFINE TABLET AREA button. As you define PORTION OF TABLET, follow any MESSAGE prompts to set the portion of your tablet that will be used for mapping.



## SETTING MOUSE SPEED

To change the screen cursor acceleration and speed when in MOUSE MODE, click on the MOUSE MODE DETAILS... button (located on the PEN tab) to display a dialog box where you can make your adjustments.

Sets the screen cursor acceleration when in MOUSE MODE.

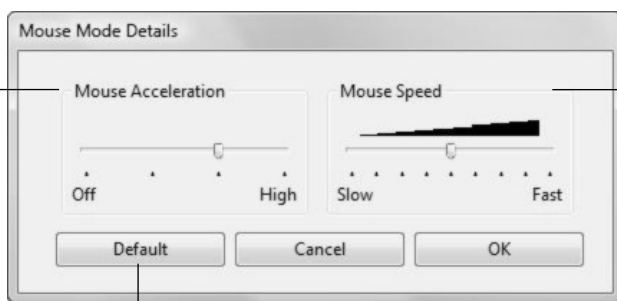

Sets the screen cursor tracking speed when in MOUSE MODE.

Returns settings to their factory defaults.

**Note:** The dialog box will also appear when you set a tool button to MODE TOGGLE.... Although MOUSE MODE settings can be accessed from a number of different locations within the control panel, only one ACCELERATION and SPEED setting can be made.



## CUSTOMIZING THE TABLET FUNCTIONS

The TABLET tab is used to customize the ExpressKeys and Touch Ring.

Use the pull-down menus to choose a function that will be performed when the key is pressed. Your choice will be displayed either within the pull-down menu or beneath the menu.

- By default, you can use the upper keys to move BACK and FORWARD within Internet browsers.
- On Windows Vista systems the lower left button defaults to JOURNAL when the Journal application is available. Otherwise, the button is set to SHOW DESKTOP.
- The default condition for the lower right button is SWITCH APPLICATION on Windows systems and EXPOSÉ on Macintosh systems.



Returns the tab settings to their factory default conditions.

To customize the Touch Ring:

- Choose a FUNCTION to perform when the Touch Ring is in use. ZOOM is the default setting. When selected, the Touch Ring enables you to zoom in or out of documents and images in the active window. You can also set the ring to SCROLL, or disable it.
- Choose an option from the pull-down menu to set the SPEED at which you would like to zoom or scroll.
- Decide if you want to enable fast scrolling. When checked (the default setting), ENABLE FAST SCROLLING allows you to scroll simply by tapping the upper or lower portion of the Touch Ring with your finger. See using the Touch Ring for details on working with this function.





## TROUBLESHOOTING

Most of the time your tablet will work flawlessly. But if you are having trouble, Wacom recommends you do the following:

1. If the pen tablet driver failed to load properly, first perform the recommended action in any error message that may appear on your screen. If that does not solve the problem, refer to the troubleshooting procedures in this chapter.
2. Look in the [troubleshooting tables](#). Your problem may be described there and you can try the solution offered.
3. Open the pen tablet Read Me file for late-breaking information.
4. Test your tablet and pen. See [testing your tablet and pen](#).
5. If you are having a compatibility conflict between Bamboo and a new hardware or software product, check if a newer pen tablet software driver is available. See [obtaining driver downloads](#) for information on downloading an updated software driver. Wacom periodically updates the software driver to maintain compatibility with new products.
6. Check the FAQs (Frequently Asked Questions) on the Wacom web site for your region.
7. If you have tried the suggestions in this manual and still cannot resolve the problem, then contact Wacom for technical support. See [technical support options](#) and the Read Me file for information on where to obtain support for your region.

[Testing your tablet and pen](#)

[Troubleshooting tables](#)

[Technical support options](#)

[Obtaining driver downloads](#)





## TESTING YOUR TABLET AND PEN

1. Turn on your computer and wait until the system has fully loaded.
2. **Check the connection.** The tablet ExpressKeys should glow whenever the tablet is properly connected and your computer has registered it as a USB device. If not:
  - Make sure the tablet USB cable is securely connected to the tablet and to an active USB port on your computer.
  - If you are connecting the tablet to a USB hub (or hub device such as a keyboard with USB ports), be sure the USB hub is properly connected to your computer and is active.
  - Check the cable for damage or try using a different, compatible cable.
  - Connect the tablet to a different USB port or try connecting to the USB port on another computer.
  - If the tablet ExpressKeys do not illuminate after your computer is on and has finished booting up, your USB port may be disabled. Verify that you have connected the tablet to an active USB port.
3. **Activate the tablet diagnostics.** First open the Pen Tablet control panel and select the TABLET tab. Use the pull-down menus to DISABLE all of the ExpressKeys. Now press both the upper left and lower right ExpressKeys and hold them down for three (3) seconds.
  - Do a quick check of the ExpressKeys by pressing each one in turn. All of the ExpressKeys should glow at a brighter level each time you press a key.
  - Do a quick check of the Touch Ring by sliding your finger around it. All of the ExpressKeys should glow at a brighter level when you touch the ring.
  - **Check the pen** by first opening the Pen Tablet control panel and selecting the PEN tab. Click on the DEFAULT button to return the pen to its default settings. Next:
    - A. Touch the pen tip and then the eraser to the tablet active area. All of the ExpressKeys should glow brightly each time the tip or eraser makes contact with the tablet surface.
    - B. Without applying pressure to the pen tip, hold the pen tip within approximately 5 mm (0.20 inch) of the tablet surface and press each pen button in turn. All of the ExpressKeys should glow brightly each time a pen button is pressed
    - C. While still within proximity, but without touching the tablet surface, move your pen across the active area of the tablet. The screen cursor should move in the corresponding direction on your monitor or display screen.

When you are done, exit the diagnostics mode by pressing both the upper left and lower right ExpressKeys and holding them down for three (3) seconds. In the Pen Tablet control panel, select the TABLET tab and use the pull-down menus to return the ExpressKeys to their previous settings.





4. **Check the Touch Ring.** Open the Pen Tablet control panel and select the TABLET tab. Click on the DEFAULT button to return to the tablet default settings.
  - Open a Microsoft Office or image file.
  - Move your finger in a clockwise direction along the Touch Ring to zoom in on the image.
  - Move your finger in a counterclockwise direction along the Touch Ring to zoom out of the image.
5. **Check the ExpressKeys.** Open the Pen Tablet control panel and select the TABLET tab. Click on the DEFAULT button to return to the tablet default settings.
  - Open your Internet browser and click on a couple of links. Press the upper left ExpressKey to move back within the browser. Press the upper right key to move forward within the browser.
  - Press the lower left ExpressKey. For Windows Vista, Microsoft Journal should launch if the application is available. Otherwise, all open windows should minimize to display a clean desktop.
  - Press the lower right ExpressKey. On Windows Vista systems running Aero, Flip 3D should be activated with focus on the next open application. Otherwise, the Windows application switching dialog should appear with focus on the next open application. On Macintosh systems, all open windows should be tiled.
6. If any of these tests fail you may have defective hardware. See [technical support options](#).
7. After testing, use the Pen Tablet control panel to reconfigure your tablet and pen for any custom settings you may originally have been using.





## TROUBLESHOOTING TABLES

If you encounter problems with your Bamboo pen or tablet, refer to the following tables. Your problem may be described here, and you can try the solution offered. Be sure you refer to the Read Me file for the latest information updates.

For additional information, visit Wacom's web site at <http://www.wacom.com/productsupport> and follow the links to the FAQs.

[General problems](#)

[Windows-specific problems](#)

[Macintosh-specific problems](#)

## GENERAL PROBLEMS

The computer does not have an available USB port.	Check if there is an available USB port on a USB hub device. If not available you will need to add a USB hub or USB card.
The tablet ExpressKeys do not illuminate.	Verify that your tablet's USB cable is properly connected to the tablet and to an active USB port. If you are connecting to a USB hub device, make sure the hub is connected to an active USB port and that the hub is active.
When using the pen to operate the Touch Ring, the Touch Ring does not work well.	The Touch Ring is designed to be used with your finger or similar shaped object, and does not work well with the pen tip due to its small contact area.
The pen works only in MOUSE MODE, and does not ink or sketch with pressure sensitivity.	The tablet driver software was not installed or did not load properly. Make sure the tablet driver software is installed and functioning. Insert the Bamboo Pen Tablet Driver CD into your computer and install the driver software for the tablet.
The pen does not ink or sketch with pressure sensitivity.	Some applications require that you turn on the pressure capabilities within the application or the selected tool before the pen will respond as a pressure-sensitive tool.
Clicking is difficult.	Try using a lighter TIP FEEL (see <a href="#">adjusting tip feel and double-click</a> ). Select the CLICK SOUND option (the check box should be checked) so that you can hear when the pen registers a mouse click. Your computer speakers must be turned on and the volume audible before you can hear CLICK SOUND.





Double-clicking is difficult.	<p>Be sure you are quickly tapping the tablet twice in the same place on the tablet active area.</p> <p>Using a pen button to double-click is recommended (review the techniques in <a href="#">clicking</a>).</p> <p>See <a href="#">adjusting tip feel and double-click</a>:</p> <ul style="list-style-type: none"> <li>• Try increasing the DOUBLE CLICK DISTANCE.</li> <li>• Try using a lighter TIP FEEL.</li> </ul> <p><b>Windows:</b> Try setting your system to launch programs with a single click. See <a href="#">clicking</a>.</p>
The pen selects everything, will not stop selecting.	Open the Pen Tablet control panel and go to the PEN tab. Move the TIP FEEL slider toward FIRM. If this does not help, see <a href="#">testing your tablet and pen</a> .
The eraser selects everything or will not stop erasing.	See <a href="#">testing your tablet and pen</a> .
You notice a screen delay at the beginning of inking strokes.	Try decreasing the DOUBLE CLICK DISTANCE (see <a href="#">adjusting tip feel and double-click</a> ).
You have to press hard with the pen when clicking or writing.	Open the Pen Tablet control panel and go to the Pen tab. Move the TIP FEEL slider toward SOFT.
The pen tip does not function.	<p>Be sure you are using the pen that originally came with your pen tablet. Other pens may not function properly on the Bamboo tablet.</p> <p>See <a href="#">testing your tablet and pen</a> to verify pen operation. If any of the tests fail you may have defective hardware.</p>
The upper or lower pen button does not work.	<p>Be sure you press the pen button when the pen tip is within 5 mm (0.20 inch) of the tablet active area – do this without pressing down on the pen tip.</p> <p>In the Pen Tablet control panel, click on the PEN tab ADVANCED button. If CLICK &amp; TAP is selected, you will need to first press the pen button and then touch the pen tip to the tablet surface in order to perform a click function. See <a href="#">customizing the pen buttons</a>.</p> <p>From the Pen Tablet control panel, verify that the pen button is set to the function you are expecting to occur.</p> <p>See <a href="#">testing your tablet and pen</a> to verify pen operation. If any of the tests fail you may have defective hardware.</p>
The screen cursor jumps back.	Do not place the pen on the tablet when it is not in use or when you are using another pointing device. Leaving your pen on the tablet may interfere with screen cursor positioning when using other input devices.





Cannot move the cursor where you want to on the screen, or the line you are sketching does not line up with the location of the pointer in paint applications.

Open the Pen Tablet control panel. Verify that PEN MODE is selected. If this does not help, click on the DEFAULT button to reestablish the default tablet to screen mapping. If you are still having difficulty, remove the tablet preferences (see next tip).

You suspect the tablet preferences may be corrupted, or want to make certain that all settings are at their factory defaults.

Delete the tablet preferences as follows:

**Windows:** Click the START icon and select ALL PROGRAMS. Then select TABLET or PEN TABLET and TABLET or PEN TABLET PREFERENCE FILE UTILITY. In the dialog box that appears, click on the REMOVE MY PREFERENCE FILE button to delete the preferences for the current user. To delete preferences for multiple users on Windows Vista or XP systems, click on the REMOVE ALL PREFERENCE FILES button. Note that administrator rights are required to delete preferences for all users. Relaunch any currently open tablet-aware applications that you may be running.

**Macintosh:** For a single user, delete the tablet preferences by first choosing your HOME folder from the GO menu. Then open your home LIBRARY folder. Within your home LIBRARY folder, open the PREFERENCES folder and delete the COM.WACOM.PENTABLET.PREFS file. Log out, then log back in. When the tablet driver loads it will create a new preferences file with the factory defaults.

For multiple users, delete all tablet preferences by first opening the main APPLICATIONS folder. Then open the TABLET folder and run the REMOVE PEN TABLET utility. When the utility starts, click on the REMOVE ALL PREFERENCE FILES button. Log out, then log back in. When the tablet driver loads, it will create new preferences files with the factory defaults.

**Note:** Do not manually remove the PEN TABLET.PREFPANE file from the main LIBRARY PREFERENCEPANES folder. This file is only to be removed when uninstalling the tablet software driver, and then only when using the REMOVE PEN TABLET utility.

The computer does not go to sleep.

When you are not using the pen, remove it from the tablet surface or the tablet will continue to send data, keeping the computer awake.

When using the tablet the screen cursor is very erratic or jumps around.

On rare occasions the tablet may receive interfering radio frequencies from a computer monitor or nearby AM radio station. If you notice interference from a monitor, try moving the tablet at least six (6) inches away from the monitor, or change the monitor refresh rate or monitor resolution.





## WINDOWS-SPECIFIC PROBLEMS

After changing right- and left-handed settings in the system's Mouse control panel, the pen tip no longer functions properly.

This will reverse the right and left button settings on your Wacom tools. Restart Windows for your Wacom tool settings to be correctly recognized.

## MACINTOSH-SPECIFIC PROBLEMS

At startup, a dialog box appears telling you that either the driver failed to load or the tablet preferences have not yet been created.

The tablet was not detected at startup. Make sure the USB interface cable is securely connected to the tablet and to an active USB port on your computer. Make sure also that the tablet ExpressKeys are illuminated. If your tablet is plugged into a USB hub, make sure the hub is connected and active.

From the GO menu, select the UTILITIES folder and launch the SYSTEM PROFILER. Select USB from the HARDWARE section of the CONTENTS list. A Wacom USB tablet model should be listed. If a tablet model is not listed, check the USB tablet cable connection or try plugging the tablet into a different USB port.

If this does not help, contact Wacom for technical support. See [technical support options](#).

Inkwell does not work correctly with the tablet.

There may be a problem with the Inkwell preferences. Remove the damaged preference files as follows. They will be recreated when you enable handwriting recognition.

1. From the Apple menu, choose SYSTEM PREFERENCES. From the System Preferences menu, choose SHOW ALL and select INK. Then turn off handwriting recognition.
2. From the GO menu, choose your HOME. Open the LIBRARY and PREFERENCES folders. Then remove the following preferences:
  - com.apple.ink.framework.plist
  - com.apple.ink.inkpad.plist
  - com.apple.ink.inkpad.sketch
3. Go back to SYSTEM PREFERENCES and INK, and then enable handwriting recognition.
4. Test the Inkwell function using your pen tablet and pen.
5. If this procedure does not resolve your problem with Inkwell, contact Apple Support for further assistance. Wacom is not the software manufacturer for Inkwell and we are limited in our abilities to support a third party software application.





## TECHNICAL SUPPORT OPTIONS

If you have a problem with your pen tablet, first check the tablet installation guide to be sure the unit is installed correctly. Then review the [troubleshooting](#) procedures within this manual; your problem may be described there and you can try the solution(s) offered.

If you cannot find the answer in this manual, you may find updated information about your problem in the Read Me file for your platform (located on the Bamboo Pen Tablet Driver CD). You can also check the product FAQs (Frequently Asked Questions) on the Wacom web site for your region.

If you have an Internet connection you can download the latest software drivers from the Wacom web site for your region. See [obtaining driver downloads](#) for your region.

If you cannot solve the problem and you think your pen tablet is not working properly, contact the Wacom support staff for the area where your product was purchased. See the pen tablet Read Me file, located on the Bamboo Pen Tablet Driver CD, for contact information.

When you call, you should be at your computer with the following information available:

- This manual.
- Tablet serial and model number. (Look on the bottom of the tablet.)
- Driver version number. (See the Bamboo Pen Tablet Driver CD or the Pen Tablet control panel.)
- The make and model of your computer, and operating system version number.
- A list of peripheral devices attached to your computer.
- The software application and version you were using when the problem occurred.
- The exact wording of any error message that appeared on your screen.
- What happened and what you were doing when the problem occurred.
- How you tried to solve the problem.





## OBTAINING DRIVER DOWNLOADS

Wacom periodically updates the tablet software driver to maintain compatibility with new products. If you are having a compatibility problem between Bamboo and a new hardware or software product, it may be helpful to download a new pen tablet software driver (when available) from the Internet.

### USA, Canada, Central and South America

Worldwide Web: <http://www.wacom.com/productsupport> Driver downloads.

### Europe, Middle East and Africa

Worldwide Web: <http://www.wacom.eu> Software updates.

Anonymous FTP Site: <ftp://ftp.wacom.eu/pub/> Software updates.

### Japan

Worldwide Web: <http://tablet.wacom.co.jp> Software updates. (Japanese)

### Asia Pacific (English)

Worldwide Web: <http://www.wacom-asia.com> Software updates. (English)

### China

Worldwide Web: <http://www.wacom.com.cn> Software updates.  
(Simplified Chinese)

### Korea

Worldwide Web: <http://www.wacomdigital.co.kr> Software updates. (Korean)

### Taiwan

Worldwide Web: <http://www.wacom.com.tw> Software updates.  
(Traditional Chinese)





## APPENDIX

This section contains information about digital inking, tips on caring for your tablet and tools, instructions on how to uninstall the tablet software, your license and warranty, and more.

[Pen and digital ink capabilities in Windows Vista](#)

[Caring for your tablet and tools](#)

[Uninstalling the tablet software](#)

[Product specifications](#)

[Product information](#)

[Ordering parts and accessories](#)

[Radio and television interference](#)

[License and Warranties \(Worldwide, except for Europe, Africa and Middle East\)](#)

[License and Warranty \(Europe, Africa and Middle East\)](#)





## PEN AND DIGITAL INK CAPABILITIES IN WINDOWS VISTA

Microsoft Windows Vista provides extensive support for pen and touch input. When using Bamboo with a computer running Windows Vista, your experience is enhanced by powerful note taking, handwriting recognition, fast navigation, and other digital inking options designed to give you quick, intuitive results with the Bamboo pen.

- **Note taking.** Use your Bamboo pen to jot notes and capture quick sketches in Microsoft Journal. Journal simulates a physical notebook, but with the advantages of digital note taking – you can choose from a variety of pen, marker, and highlighter tools, plus an eraser that is easily activated by the eraser end of your Bamboo pen. Journal also includes a powerful search engine that can even locate your handwritten content.
- **Handwriting recognition.** Because Windows Vista includes powerful handwriting recognition capabilities, you can use your Bamboo pen to quickly enter handwritten information anywhere the computer accepts typed input. You can convert your handwritten content to typed text at any time.
- **Gestures.** Use your Bamboo pen to make simple gestural movements on the tablet to trigger customizable actions for navigation, editing, and other functions. To customize your gestures, select the FLICKS tab in the PEN AND INPUT DEVICES control panel.
- **Digital Ink in Microsoft Office 2007.** Use your Bamboo pen to full advantage with the enhanced digital mark-up and inking tools available in Microsoft Office 2007 applications running on Windows Vista. Found on the REVIEW tab within applicable applications, these tools provide a consistent set of inking options. For quick access, you can add specific inking tools to the Quick Access Toolbar located at the top of each application.





## ABOUT THE WINDOWS VISTA TABLET PC INPUT PANEL

The Windows Vista Tablet PC Input Panel enables you to use handwriting or an on-screen keyboard to directly enter text with your Bamboo pen. There are a number of ways to launch the Input Panel:

- Click on the Input Panel icon which appears when you move the screen cursor into a text entry area.
- Click on the Input Panel tab, located by default on the left edge of the display screen.
- Click on the Tablet PC Input Panel icon located on the Windows taskbar. If the icon is not visible, right-click on the taskbar, select TOOLBARS, and TABLET PC INPUT PANEL.

To customize the Input Panel:

1. First open the Input Panel and then click on TOOLS in the menu bar.
2. Select OPTIONS to open the Input Panel Options dialog box.
3. Customize the Input Panel settings for the way you like to work.

To learn more about using your Bamboo pen in Microsoft Windows Vista and Office 2007, be sure to study the documentation that came with your system and Microsoft Office applications. Be sure to take advantage of the Windows Vista training tools, including the Tablet PC tutorial, available from Microsoft.

You can visit also the Wacom web site at [www.wacom.com/vista](http://www.wacom.com/vista) for additional information on working with your Bamboo pen in Windows Vista.





## CARING FOR YOUR TABLET AND TOOLS

Keep your Bamboo pen and tablet surface clean. Dust and dirt particles can stick to your pen and cause excessive wear to the tablet surface. Regular cleaning with a soft, damp cloth will help to prolong the life of your tablet surface and pen; you can also dampen the cloth using a very mild soap diluted with water. Do not use volatile liquids, such as paint thinner or benzene, as they may damage the plastic case.

Keep your tablet and pen in a clean, dry place and avoid extremes in temperature. Room temperature is best. Also, your pen and tablet are not made to come apart. Twisting the pen case can break the pen. Taking apart the product will void your warranty.

**Important:** Take care to never spill liquids onto the tablet or pen. Be especially careful of getting the tablet ExpressKeys or pen buttons, tip, and eraser wet – they contain sensitive electronic parts that will fail if liquid enters them.

## REPLACING THE PEN TIP

The pen tip (nib) will wear with normal use. When the nib gets too short or develops a flat point, you can replace it with another nib. Simply clasp the old nib with a tweezer, needle-nosed plier, or similar instrument and pull it straight out of the pen. Then slide the end of the new nib straight into the barrel of the pen – firmly push the nib until it stops.

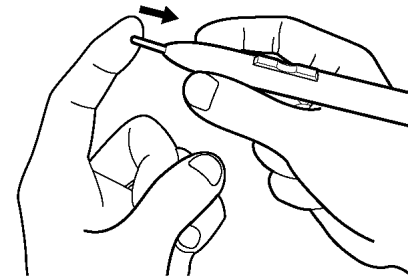
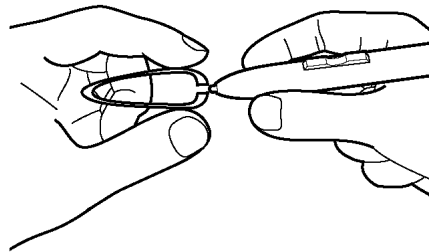
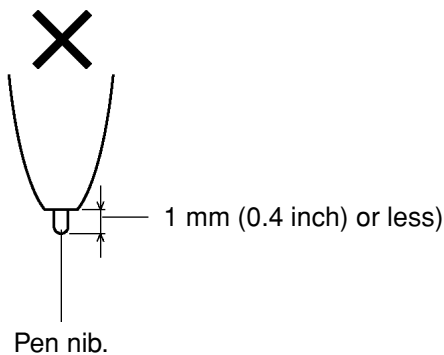

**Important:** When the Bamboo pen is not in use, place it in the pen stand or lay it flat on your desk. To maintain the sensitivity of your pen, do not store the pen in a container where it will rest on the tip or eraser.

**Warning:** Prevent children from swallowing the pen tip or pen buttons. The pen tip (nib) or pen buttons may accidentally be pulled out if children are biting on them.

To order replacement parts, see [ordering parts and accessories](#).





## UNINSTALLING THE TABLET SOFTWARE

Follow the appropriate procedure below to remove the pen tablet driver software from your system.

**Important:** When you remove the pen tablet software from your system, your pen tablet will no longer operate with full tablet functionality but will continue to function as a mouse device.

**Windows Vista:** Click on the Windows START button and choose CONTROL PANEL. In the CONTROL PANEL window, click on PROGRAMS AND FEATURES. In the dialog box that appears, choose the TABLET or PEN TABLET option. Click on the UNINSTALL button and follow the prompts to remove the tablet driver. (If prompted, enter your administrator login name and password.)

**Windows XP or XP x64:** Click START. In the start menu, select CONTROL PANEL. Then select ADD OR REMOVE PROGRAMS. In the ADD OR REMOVE PROGRAMS window, choose TABLET or PEN TABLET and click on the REMOVE button. Follow the prompts to remove the tablet driver.

**Windows 2000:** Click the Windows START button. Then choose SETTINGS and CONTROL PANEL. In the CONTROL PANEL window, double-click on the ADD/REMOVE PROGRAMS icon. In the dialog box that appears, choose the TABLET or PEN TABLET option. Click on the ADD/REMOVE... button and follow the prompts to remove the tablet driver.

**Macintosh:** From the GO menu, choose APPLICATIONS and open the PEN TABLET folder. Double-click on the REMOVE PEN TABLET icon and select the REMOVE TABLET SOFTWARE button. Enter your administrator login name and password. After the removal is completed, click OK.





## PRODUCT SPECIFICATIONS

### GENERAL SPECIFICATIONS

Coordinate resolution	100 lpmm (2540 lpi)
Accuracy, pen	+/- 0.5 mm (0.02 in)
Reading height with pen, average	3 to 5 mm (0.12 to 0.20 in)
Report rate	133 points per second
Tablet ExpressKeys stroke	0.25 mm (0.01 in), approximately
Communication interface	USB
Connector	USB A
Power requirements	DC 5V, 70 mA or less, from USB port
Operating temperature	5 to 40 degrees C (41 to 104 degrees F)
Storage temperature	-10 to +60 degrees C (14 to 140 degrees F)
Operating relative humidity	20% to 80% noncondensing
Storage relative humidity	20% to 90% noncondensing
Certifications and compliance	FCC Class B, CE, VCCI Class B, BSMI, C-Tick, MIC, GOST-R, CCC, RoHS, Chinese RoHS, Industry Canada Class B

### BAMBOO TABLET (MODEL MTE-450)

Active area (W x D)	147.6 x 92.3 mm (5.82 x 3.64 in)
Physical size (W x D x H)	200 x 186 x 10.7 mm (7.88 x 7.33 x 0.42 in), including rubber feet
Aspect ratio	16 : 10
Cable length	1.5 m (4.95 ft)
Weight	370 g (0.81 lb), approximately, including cable
Power consumption	0.35 watts, approximately

### BAMBOO PEN (MODEL EP-150E)

Physical size (L x D)	142.5 x 11.4 mm (5.61 x 0.45 in)
Pressure levels, pen tip	512 levels
Pen tip travel	0.1 mm (0.004 in), approximately
Eraser tip travel	1.0 mm (0.039 in), approximately
Weight	12 g (0.03 lb), approximately
Pen tip type	Polyacetal (Part No. PSI-A048-01), black





## PRODUCT INFORMATION

To learn more about Bamboo and how to take full advantage of the many pen and digital inking features in Microsoft Windows Vista, visit the Wacom web site for your region:

USA, Canada, Central and South America	<a href="http://www.wacom.com/productinfo">http://www.wacom.com/productinfo</a>
Europe, Middle East and Africa	<a href="http://www.wacom.eu">http://www.wacom.eu</a>
Japan	<a href="http://tablet.wacom.co.jp">http://tablet.wacom.co.jp</a>
Asia Pacific (English)	<a href="http://www.wacom-asia.com">http://www.wacom-asia.com</a>
China (Simplified Chinese)	<a href="http://www.wacom.com.cn">http://www.wacom.com.cn</a>
Korea	<a href="http://www.wacomdigital.co.kr">http://www.wacomdigital.co.kr</a>
Taiwan	<a href="http://www.wacom.com.tw">http://www.wacom.com.tw</a>
Thailand	<a href="http://www.wacom-thai.com">http://www.wacom-thai.com</a>

## ORDERING PARTS AND ACCESSORIES

To purchase parts and accessories, refer to the tablet Read Me file and see who to call for your region.

You can also do the following:

- **To purchase parts and accessories in the USA or Canada**, call 1.888.884.1870 (toll-free) or visit Wacom's web site at <http://www.wacomdirect.com> (USA only).
- **To purchase parts and accessories in Europe**, call +49 (0)180.500.03.75 or send an email to [spareparts@wacom.eu](mailto:spareparts@wacom.eu). Or, visit the Wacom web site at [www.wacom.eu/solutionstore](http://www.wacom.eu/solutionstore). You can also contact your local dealer, distributor, or technical support using the appropriate number for your region.
- **To purchase parts and accessories in other countries**, please contact your local dealer or distributor.

Please note that not all parts and accessories are available in all regions.





## RADIO AND TELEVISION INTERFERENCE

The equipment described in this manual generates, uses, and can radiate radio-frequency energy. If it is not installed and used properly—that is, in strict accordance with Wacom instructions—it may cause interference with radio and television reception.

### FCC NOTICE

This device complies with Part 15 of the FCC Rules. Operation is subject to the following two conditions: (1) this device may not cause harmful interference, and (2) this device must accept any interference received, including interference that may cause undesired operation.

This equipment has been tested and found to comply with the limits for a Class B digital device, pursuant to Part 15 of FCC Rules. These limits are designed to provide reasonable protection against harmful interference in a residential installation.

This equipment generates, uses and can radiate radio frequency energy and, if not installed and used in accordance with the instructions, may cause harmful interference to radio communications. However, there is no guarantee that interference will not occur in a particular installation.

You can determine whether the equipment is causing interference by disconnecting it from your computer. If the interference stops, it was probably caused by the equipment.

If the equipment does cause interference to radio or television reception, you may be able to correct the interference by using one or more of the following measures:

- Rotate the television or radio antenna until the interference stops.
- Move the equipment farther away from the television or radio.
- Plug the equipment and computer into an outlet that is on a different circuit from the television or radio.

If necessary, consult your Wacom dealer or an experienced radio/television technician for help.

Changes or modifications to this product not authorized by Wacom could void the FCC Certification and negate your authority to operate the product.

## INDUSTRY CANADA (CANADA ONLY)

### Industry Canada, Class B

“This Class (B) digital apparatus complies with Canadian ICES-003”

“Cet appareil numérique de la classe (B) est conforme a la norme NMB-003 du Canada.”

## CE DECLARATION

The Wacom Bamboo™ digitizing tablet, model MTE-450, has been tested and found to comply with the following harmonized European Norms:

- EN 55024 (electromagnetic immunity)
- EN 55022 Class B (electromagnetic emissions)

Based on the results of these tests, Wacom declares that the above mentioned device conforms to Article 10.1 of the European Council Directive 89/336/EEC, and their amendment Directive 93/68/EEC and indicates this conformity by the CE-sign on each device.

The device must be installed and operated always in strict accordance with the instructions given in this handbook. Any changes or modifications to this product that were not specifically authorized will invalidate this declaration.





## LICENSE AND WARRANTIES

(WORLDWIDE, EXCEPT FOR EUROPE, AFRICA AND MIDDLE EAST)

### SOFTWARE LICENSE

This legal document is an agreement between you, the end-user, and Wacom Technology Corporation (Wacom).

**1. Grant of License.** The enclosed product includes computer programs embedded in firmware and accompanying diskette or CD-ROM (the "Software"). The Software is licensed, not sold, to you for use only with Wacom products upon the terms of this license, and Wacom reserves any rights not expressly granted to you. Wacom grants to you a non-exclusive right to use this copy of the Software in conjunction with a Wacom product at a single location.

**2. Ownership of Software.** Although you may own the product in which the Software is originally recorded, Wacom retains ownership of the Software itself. You acknowledge that the Software is Wacom's property, and contains valuable confidential, unpublished information developed or acquired by Wacom at great expense, including data processing algorithms, innovations and concepts. The Software is protected by copyright and other federal and state laws. You agree to use your reasonable best efforts to protect the Software from unauthorized reproduction, distribution, disclosure, use, or publication.

**3. Copy Restrictions.** Unauthorized copying of the Software is expressly forbidden.

**4. Use Restrictions.** You may not decompile, reverse assemble, disassemble or reverse engineer the Software.

**5. Termination.** This License is effective until terminated. This License will terminate automatically without notice from Wacom if you fail to comply with any provisions of the License.

**6. Miscellaneous.** This License is governed by the laws of the United States of America and the state of Washington except in Asia Pacific and by the laws of Japan for Asia Pacific.

### LIMITED WARRANTY

Wacom warrants the product, to the original consumer purchaser, except for the Software and consumable items such as the pen nibs, to be free from defects in materials and workmanship under normal use and service for a period of one (1) year, from the date of original retail purchase, as evidenced by a copy of the receipt and registration with Wacom within 30 days of purchase.

The Software is licensed "as is." Wacom makes no warranty with respect to its quality or performance. Wacom cannot guarantee you uninterrupted service or the correction of any errors.

*Upon discovery of a defect in the product, except in the Software, within the Warranty Period, you should contact Wacom Technical Support via telephone, email, or fax to obtain an RMA (Return Merchandise Authorization) number and instructions for shipping the product to a service location designated by Wacom. You should send the product, shipping charges prepaid, to the designated service location, accompanied by the return authorization number, your name, address and telephone number, proof of purchase date, and a description of the defect. Wacom will pay for return shipping by United Parcel Service or by an equivalent service as chosen by Wacom.*





Wacom's sole obligation and entire liability under this warranty shall be, at Wacom's option, either the repair or replacement of the defective product or parts thereof of which Wacom is notified during the Warranty Period; provided, however, that you are responsible for (i) the cost of transportation of the product to the designated service location and (ii) any loss or damage to the product resulting from such transportation.

Wacom shall have no responsibility to repair or replace the product if the failure of the product has resulted from accident, abuse, misuse, negligence, or unauthorized modification or repair, or if it has been handled or stored other than in accordance with Wacom's storage instructions.

Any descriptions, drawings, specifications, samples, models, bulletins, or similar material, used in connection with the sale of the product, shall not be construed as an express warranty that the product will conform or comply with your requirements.

EXCEPT FOR THE LIMITED WARRANTY DESCRIBED ABOVE, THERE ARE NO OTHER WARRANTIES MADE BY WACOM ON THIS PRODUCT. NO ORAL OR WRITTEN INFORMATION OR ADVICE GIVEN BY WACOM, ITS DEALERS, DISTRIBUTORS, AGENTS, OR EMPLOYEES SHALL CREATE A WARRANTY OR IN ANY WAY INCREASE THE SCOPE OF THIS WARRANTY, AND YOU MAY NOT RELY ON ANY SUCH INFORMATION OR ADVICE. THIS WARRANTY GIVES YOU SPECIFIC LEGAL RIGHTS, AND YOU MAY ALSO HAVE OTHER RIGHTS WHICH VARY FROM STATE TO STATE.

WACOM LIMITS THE DURATION OF ANY LEGALLY IMPLIED WARRANTIES INCLUDING IMPLIED WARRANTIES OF MERCHANTABILITY OR FITNESS FOR A PARTICULAR PURPOSE, TO THE DURATION OF WACOM'S EXPRESS WARRANTY. SOME STATES DO NOT ALLOW LIMITATIONS ON HOW LONG AN IMPLIED WARRANTY LASTS, SO THE ABOVE LIMITATION MAY NOT APPLY TO YOU.

NEITHER WACOM NOR ANYONE ELSE WHO HAS BEEN INVOLVED IN THE CREATION, PRODUCTION, OR DELIVERY OF THIS PRODUCT SHALL BE LIABLE FOR ANY DIRECT, CONSEQUENTIAL, OR INCIDENTAL DAMAGES (INCLUDING DAMAGES FOR LOSS OF BUSINESS PROFITS, BUSINESS INTERRUPTION, LOSS OF BUSINESS INFORMATION AND THE LIKE) ARISING OUT OF THE USE OF OR INABILITY TO USE SUCH PRODUCT, EVEN IF WACOM HAS BEEN ADVISED OF THE POSSIBILITY OF SUCH DAMAGES. SOME STATES DO NOT ALLOW THE EXCLUSION OR LIMITATION OF INCIDENTAL OR CONSEQUENTIAL DAMAGES, SO THE ABOVE LIMITATION OR EXCLUSION MAY NOT APPLY TO YOU.

In the event that any of the above limitations are held unenforceable, Wacom's liability for any damages to you or any party shall not exceed the purchase price you paid, regardless of the form of any claim.

This Limited Warranty is governed by the laws of the United States of America and the state of Washington.

This Limited Warranty is valid for and only applies to products purchased and used inside the United States (and its territories or possessions) and Canada.

## WARRANTY SERVICE IN THE U.S.A. AND CANADA

To obtain Warranty service within the U.S. or Canada contact:

Wacom Technical Support

Phone: 1.360.896.9833

Fax: 1.360.896.9724

Inquiry form: <http://www.wacom.com/productsupport/email.cfm>

E-mail: [support@wacom.com](mailto:support@wacom.com)





## WARRANTY ON SALES OUTSIDE OF THE U.S.A. AND CANADA

For products purchased or used outside of the United States and Canada, upon discovery of a defect in the product, except in the Software, within the Warranty Period you should contact your local dealer or distributor. In all other respects the terms of the warranty as set forth above apply to such sales.

### Wacom Technical Support in Asia Pacific (except Japan and China)

Detailed Asia Pacific Limited Warranty policy and product registration may be found online at <http://www.wacom-asia.com>

To obtain Warranty service within Asia Pacific, please contact the local Wacom Office, distributor or the Asia Pacific Office in Tokyo.

For local distributor contact information, please visit: [http://www.wacom-asia.com/distributor/dist\\_index.php](http://www.wacom-asia.com/distributor/dist_index.php)

Phone: +81-3-3509-1588

Inquiry form: <http://club.wacom.co.jp/support-en/servlet/support.user.Swusr200Sv00>

Should you have any questions about this Agreement, or if you desire to contact Wacom for any reason, please contact in writing:

#### In North and South America contact:

Wacom Technology Corporation  
1311 S.E. Cardinal Court  
Vancouver, Washington 98683  
U.S.A.

#### In Japan contact:

Wacom Co., Ltd.  
2-510-1 Toyonodai  
Otone-Machi, Kitasaitama-Gun  
Saitama, 349-1148  
Japan

#### In Asia Pacific contact:

Wacom Co., Ltd.  
Harmony Tower 18F, 1-32-2 Hon-Cho,  
Nakano-Ku, Tokyo 164-0012  
Japan

#### In Mainland China (Except Hong Kong) contact:

Wacom China Corporation  
1108, Block One, Kuntai International Bldg,  
12 Chao Wai Street, Chao Yang District,  
Beijing, China 100020  
E-mail: [support@wacom.com.cn](mailto:support@wacom.com.cn)





## LICENSE AND WARRANTY (EUROPE, AFRICA AND MIDDLE EAST)

### SOFTWARE LICENSE AGREEMENT

#### Important Notice to Customers

This product contains copyrighted computer programs (“software”) which are the inalienable intellectual property of Wacom Europe GmbH (“Wacom”). This software is both integrated within the product and also contained on the accompanying data carrier. The purchase of this product from your dealer does not include Wacom’s software and the associated rights of usage. Wacom grants you, the user, the right to use the software solely in accordance with the conditions of this software license agreement. By purchasing this product you agree to the terms of this license.

### ENTITLEMENT TO USE THE SOFTWARE

Wacom grants the customer a personal, non-exclusive license to use the software solely in combination with this product and for the proper operation of this product. This license may be transferred only in connection with this product.

The use of this software includes solely the permanent or temporary, complete or partial copying of the software by means of loading, displaying, executing, transmitting or saving for the purpose of executing the commands and data it contains or of observing, examining or testing the functions of the software.

The customer may not license, lease or loan the software to a third party, nor allow a third party to access the software in any other way. The customer may not without prior written authorization from Wacom copy, modify, transmit or edit the software, apart from the actions of copying necessary to create a backup copy and for the purposes outlined in section 2 above.

The customer may not decompile the software; if the software contains interfaces to software which is not supplied by Wacom, Wacom shall make the necessary information available to the customer upon request, provided that the customer can prove his/her entitlement to use the software and that he/she agrees to pay the copying and postage costs.

### LIMITED WARRANTY

Wacom warrants to you as the original end-user that the product hardware is free from defects in materials and workmanship under normal use and service for a period of TWO (2) YEARS after the date of purchase (excluding consumable items such as the pen nibs), provided that they are unused at the time of such purchase. Wacom further warrants to you the accompanying data media against defects in materials and workmanship for a period of SIX (6) MONTHS after the date of purchase.

The Software is licensed and distributed “AS IS”. Wacom makes no warranties, expressed or implied, with respect to its quality, performance, merchantability and fitness for a particular purpose (including related manuals and documentation). Wacom cannot guarantee you uninterrupted service or the correction of any errors.

Upon discovery of a defect in the product, except in the Software, within the applicable Warranty Period, you should return them in the original packaging to the place of your original purchase, together with your name, address, telephone number, a description of the problem and a copy of the original invoice. You are responsible for any loss or damage to the product resulting from such transportation. Wacom’s sole obligation and entire liability under this warranty shall be, at Wacom’s option, either the repair or the replacement of product or parts thereof that prove defective and that were returned within the applicable Warranty Period.





Wacom shall have no responsibility to repair or replace the product if (a), in the opinion of Wacom, the failure of the product has resulted from accident, abuse, misuse, negligence, misapplication, or unauthorized modification or repair, or (b) the product has been handled or stored other than in accordance with Wacom's storage instructions, or (c) the failure is due to normal wear and tear, or (d) you fail to fulfill your obligations as described above.

In case that any claim presented under warranty is found upon investigation to be either outside the duration or the scope of this warranty, or in case that the product is found to be not defective, then the cost of such investigation and repair shall be borne by you.

Any descriptions, drawings, specifications, samples, models, bulletins, or similar material, used in connection with the sale of the product, shall not be construed as an express warranty that the product will conform or comply with your requirements.

Should any provision of this agreement be declared invalid, that provision shall be treated as separate from the agreement, and the agreement shall remain in force without limitation in all other respects.

If this product is found to be defective, the purchaser may be entitled to institute legal proceedings against the seller on grounds of liability for deficiency. The statutory rights indicated with regard to the seller are not limited in any way by this warranty. Rather, this warranty affords the purchaser rights in addition to those indicated in the present text.

This limited warranty shall apply if the seller's corporate domicile is in the European Union or in Iceland, Norway, Jersey, Switzerland, Russia, the Ukraine, Rumania, Bulgaria, Croatia, Serbia, Tunisia, Turkey, Syria, the Lebanon, Jordan, Israel, Egypt, the United Arab Emirates, Iran or South Africa.

This Limited Warranty and Liability is governed by the laws of the Federal Republic of Germany.

Should you have any questions about this Agreement, or if you desire to contact Wacom for any reason, please contact in writing:

Wacom Europe GmbH  
Europark Fichtenhain A9  
47807 Krefeld  
GERMANY





## GLOSSARY

**Active area.** The writing area of the tablet where your Bamboo pen is detected.

**Aspect.** The ratio between the vertical and horizontal dimension of the tablet or display.

**Click force.** The amount of force you must apply to the tip of your pen for a click to occur.

**Digital Ink.** A broad category that typically describes handwritten content which has been created using pen-based input on a computer. This handwritten content takes the form of sketches, ink mark-up, or handwriting. The handwriting can optionally be converted to typewritten text or simply left alone for use in its original format. Depending on your system and application settings, the handwritten text you make with digital ink can be converted on-the-fly or at another time.

**Double-click distance.** The maximum distance (in screen pixels) that the cursor can move between clicks and still be accepted as a double-click. Increasing the double-click distance makes double-clicking easier, but may cause a delay in line strokes in some applications.

**Eraser-aware application.** A software application that has built-in support for the Bamboo eraser. These applications take advantage of the eraser in different ways, depending on what makes sense for the application.

**ExpressKeys.** The customizable control keys located on your pen tablet.

**Journal.** A Microsoft Windows application that electronically simulates a physical journal pad, but with the advantages of digital note-taking. For example, you can create quick sketches and jot handwritten notes that can be converted to text and sent on to colleagues for digital mark-up. Journal includes a variety of pen, marker, and highlighter tools, plus an eraser that is easily activated by the eraser end of your Bamboo pen. Additionally, your handwritten content is searchable within Journal.

**Mapping.** The relationship between your Bamboo pen position on the tablet and the cursor position on the display screen.

**Modifier.** Modifier keys include SHIFT, ALT, and CTRL for Windows, or SHIFT, CONTROL, COMMAND, and OPTION for Macintosh. You can customize your Bamboo pen or tablet buttons to simulate a modifier key.

**Mouse acceleration.** A setting that allows you to adjust the screen cursor acceleration when your Bamboo pen is in mouse mode.

**Mouse mode.** A method for positioning the screen cursor. When you place the Bamboo pen on the tablet, you can move the screen cursor with a “pick up and slide” motion similar to using a traditional mouse. This is known as relative positioning. See also [pen mode](#).

**Mouse speed.** A setting that allows you to adjust the speed at which your screen cursor moves when your Bamboo pen is in mouse mode.

**Nib.** The replaceable pen tip.





**Pen mode.** A method of positioning the screen cursor. Wherever you place your Bamboo pen on the tablet, the screen cursor will jump to the same corresponding point on the screen. This is known as absolute positioning, and is the default setting for the Bamboo pen. Also, PEN MODE allows you to quickly position the screen cursor without having to first find it and then move it across the desktop. See also [mouse mode](#).

**Pixel.** The smallest unit of measure on your monitor screen.

**Pressure sensitive.** A quality of the Bamboo pen tip that senses the amount of pressure being applied. This is used to create natural-looking handwriting, inking, and brush strokes in applications that are pressure sensitive.

**Pressure-sensitive application.** Any application that supports pressure-sensitive input.

**Proximity.** The height above the tablet [active area](#) where the Bamboo tools are detected. Refer also to the [pointing](#) section.

**Screen cursor.** The pointer on the display screen. Screen cursors come in different shapes (such as an I-beam, arrow, or box), depending on which application you are running.

**Tablet PC Input Panel (TIP).** The Microsoft Windows Vista Tablet PC Input Panel enables you to use your Bamboo pen to create handwritten notes or work with an on-screen keyboard. The Input Panel dynamically converts your handwriting to text. The information you create can then be inserted into other documents, spreadsheets, or illustrations. See also [pen and digital ink capabilities in Windows Vista](#).

**Touch Ring.** The customizable control ring located on your pen tablet.

**USB.** Universal Serial Bus. A hardware interface standard for connecting computer peripheral devices. USB ports support hot-plugging, which allows you to connect or disconnect a USB device without turning off your computer.

**Wintab.** An interface standard used by Windows applications for receiving tablet information. Bamboo supports all Wintab-compatible applications under Windows.





## INDEX

About the manual	4	Industry Canada notice	50
Accessories and parts, ordering	49	Information, product	49
Active area	11	Inking with pressure	15
Bamboo, working with	6	Interference, radio and television	50
Button functions	25	Macintosh-specific problems, troubleshooting	40
Care, for tablet and tools	46	Manual, about	4
CE declaration	50	Mapping, to multiple monitors	30
Click sound	13	Mouse Speed, setting	32
Clicking, with pen	13	Nib, replacing	46
Control panel		Ordering parts and accessories	49
opening	20	Overview, control panel	21
overview	21	Parts and accessories, ordering	49
settings	21	Pen	
Customizing		clicking with	13
acceleration	32	customizing	22
double-click	23	double-clicking with	13
pen	22	dragging with	13
pen buttons	24	erasing with	15
speed	32	holding	10
tip feel	23	pointing	12
Digital inking capabilities	44	replacing the tip	46
Double-click, customizing	23	using	9
Double-clicking, how to	13	using pen buttons	14
Dragging, with pen	13	writing and inking with pressure	15
Driver downloads, obtaining	42	Pen buttons	
Environmental conditions	46	customizing	24
Erasing, with pen	15	using	14
ExpressKeys, using	18	Pen, testing	35
Eye-hand coordination exercise	16	Pointing, with pen	12
FCC notice	50	Pressure, writing and inking with	15
Features		Product information	49
pen	7	Proportions and scale	30
tablet	6	Radio and television interference	50
Functions		Scale and proportions	30
button	25	Settings, control panel	21
tablet	33	Software	
General problems, troubleshooting	37	driver downloads	42
Holding the pen	10	uninstalling	47





Specifications		Technical support options	41
Bamboo pen	48	Testing	
general	48	pen	35
product	48	tablet	35
tablet	48	Tip feel, customizing	23
Tablet		Tip, replacing	46
customizing functions	33	Touch Ring, using	19
ExpressKeys	18	Tracking, tablet	29
features	6	Troubleshooting	34
mapping		general problems	37
area	30	Macintosh-specific problems	40
for portion of screen area	31	tables	37
for portion of tablet area	32	Windows-specific problems	40
to multiple monitors	30	Uninstalling tablet software	47
scale and proportions	30	Windows-specific problems, troubleshooting	40
storing	46	Work area, setting up	8
testing	35	Working with Bamboo	6
Touch Ring	19	Writing with pressure	15
tracking	29		
working with	17		





## WACOM INTERNATIONAL OFFICES

### Wacom Technology Corporation

1311 S.E. Cardinal Court  
Vancouver, WA 98683  
U.S.A.  
Telephone  
General: +1.360.896.9833  
Fax: +1.360.896.9724

### Wacom Co., Ltd.

2-510-1 Toyonodai  
Otone-Machi, Kitasaitama-Gun  
Saitama, 349-1148  
Japan  
Internet: <http://tablet.wacom.co.jp>

### Wacom China Corporation

1108 Block One, Kuntai International Bldg,  
12 Chao Wai Street, Chao Yang District,  
Beijing, China 100020  
Telephone  
General: +86.10.5879.0880  
Fax: +86.10.5879.0102

### Wacom Australia Pty. Ltd.

Level 5, 18 Orion Rd,  
Lane Cove West NSW 2066, Australia  
  
Telephone  
General: +61.2.9422.6700  
Fax: +61.2.9420.2272

### Wacom Europe GmbH

Europark Fichtenhain A9  
47807 Krefeld  
Germany  
Telephone  
General: +49.(0)2151.3614.0  
Fax: +49.(0)2151.3614.111

### Wacom Co., Ltd.

Asia Pacific Office  
Harmony Tower 18F, 1-32-2 Hon Cho,  
Nakano-Ku, Tokyo 164-0012  
Japan  
Telephone  
General: +81.3.5309.1513  
Fax: +81.3.5309.1514

### Wacom Digital Solutions Co., Ltd.

Gangnam Telepia B/D 9th Fl, 662-18  
Yeoksam-dong, Gangnam-gu, Seoul, 135-080  
Korea  
Telephone  
General: +82.2.557.3894  
Fax: +82.2.557.3895

### Wacom Singapore Pte. Ltd. (Singapore)

3 Bishan Place,  
CPF Bishan Building #06-08  
Singapore 579838  
Telephone  
General: +65.6258.8640  
Fax: +65.6258.8697

